

Certa 100 / Certa Compact

Certa EHEDG pump

Features and benefits

- Gentle product handling preserves high quality of product - superior viscous handling
- EHEDG Type EL Class I - now also with EHEDG Type EL Aseptic Class I
- Impressive suction capability: -0.85 bar (vacuum) / -12.3 psi (atm)
- Low shear and virtually no pulsation
- Outstanding energy efficient pumping principle - up to 50 % less power than other pumps
- Only one shaft and one seal system - different port orientations available
- Bi-directional running
- Two year warranty



Certa 100 / Certa Compact performance

Performance curves

These performance curves show the theoretical flow without consideration of slip

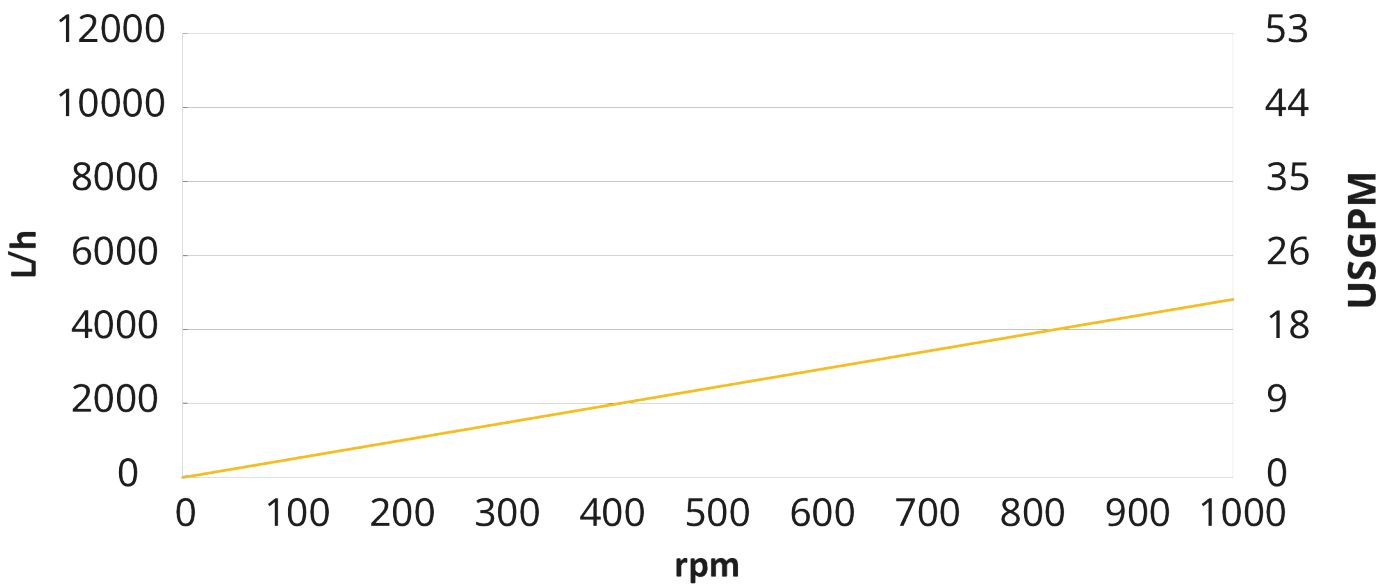

Technical specifications

	Certa 100 / Certa Compact
Max. flow rate	4800 L/h
Max. flow rate	21.1 USGPM
Volume per revolution	0.08 L
Volume per revolution	0.021 USG
Max. particle size	13 mm
Max. particle size	0.51 in
Suction pressure	85% of a vacuum
Max. operating speed	1000 rpm
Maximum operating pressure	6, 10 bar
Maximum operating pressure	87, 145 psi
Operating temperature range	-20 to 100 °C
Operating temperature range	-4 to 212 °F
Max. SIP temperature	121 °C
Max. SIP temperature	250 °F
Standards	3-A, ATEX, EHEDG Type EI Class I, EHEDG Type EL Class I Aseptic
Certification	EC 1935/2004, FDA
Port orientation	Various options to meet your requirements
Port type	Flange, Milk fitting, Others available on request, RJT, SMS, TC
Shaft diameter	28 mm
Shaft diameter	0.98 inch
Shaft height	3.74 inch
Shaft height	95 mm

*Max Operating Pressure the lowest value is for the Certa Compact

Materials of construction

	Certa 100 / Certa Compact
Housing	Stainless steel 1.4404, Stainless steel 316L
Bearing frame	Stainless steel 1.4301, Stainless steel 304
Rotor	A276 (CF10SMnN), A494 (CY5SnBiM), Hardened and chrome plated
Gate	MWR, PA6GF30, PEEK, Polyamide, POM metal detectable, PTFE, WRP, WRP PUR-Inlay
Seals/gaskets	EPDM, FKM, Others available on request
Mechanical seal	SiC/Ca-PTFE, SiC/SiC-PTFE
Double Mechanical seal	SiC/SiC
Shaft seal	PTFE, SSiC
O-Ring seal system	FKM
Single Lip seal system	PUR

Certa 100 / Certa Compact dimensions

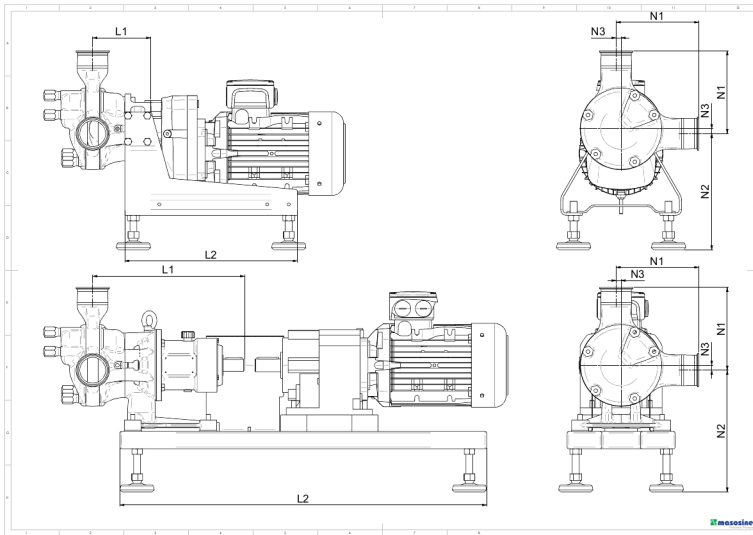

Pump size

Model	Nozzles								Length							
	N1		N2 Certa		N2 Certa Compact		N3		L1 Certa		L1 Certa Compact		L2 Certa		L2 Certa Compact	
	mm	inch	mm	inch	mm	inch	mm	inch	mm	inch	mm	inch	mm	inch	mm	inch
Certa 100	139	5.472	228 - 25	8.976 - 0.984	220 ± 25	8.661 ± 0.984	10	0.394	265	10.079	122.5	4.823	730	28.740	320	12.598
Certa 200	155	6.102	242.5 - 25	5.610 - 0.984	230 ± 25	9.055 ± 0.984	10	0.394	299	11.772	124	4.882	730	28.740	370	14.567
Certa 250	192	7.559	281 - 25	11.063 - 0.984	270 ± 25	10.630 ± 0.984	12	0.472	352	13.858	134.5	5.295	850	33.465	400	15.748
Certa 300	238	9.370	305 - 35	12.008 - 1.378	263 ± 25	10.354 ± 0.984	18	0.709	456	17.953	149	5.866	1100	43.307	480	18.898
Certa 400	324	12.756	322 - 35	12.677 - 1.378	329 ± 25	12.953 ± 0.984	31	1.221	514	20.236	174	6.850	1300	51.181	600	23.622
Certa 500	327	12.874	378 - 35	14.882 - 1.378	335 ± 25	13.189 ± 0.984	25	0.984	564	22.205	210	8.268	1300	51.181	600	23.622
Certa 600	343	13.504	380 - 35	14.961 - 1.378	352 ± 25	13.858 ± 0.984	28	1.102	639	25.158	252.5	9.941	1400	55.118	650	25.591
Certa 800	535	21.063	740	29.134	N/A	N/A	38	1.496	807	31.771	N/A	N/A	2200	86.614	N/A	N/A

Pump weight

Model	kg	lb
Certa 100	44	97
Certa 100 Compact	25.5	56
Certa 200	49	108
Certa 200 Compact	34	75
Certa 250	89	196
Certa 250 Compact	52	115
Certa 300	124	273
Certa 300 Compact	79.5	175
Certa 400	215	474
Certa 400 Compact	164.5	363
Certa 500	344	758
Certa 500 Compact	231.5	510
Certa 600	508	1120
Certa 600 Compact	411	906

Weights are estimated, based on an application with 4 bar at 250 rpm.

Disclaimer: All flow rates shown were obtained pumping water at 20 °C (68 °F) with zero suction and delivery heads. Disclaimer: The information contained in this document is believed to be correct but Watson-Marlow Limited accepts no liability for any errors it contains and reserves the right to alter specifications without notice. Watson-Marlow, MasoSine, Qdos, ReNu, LoadSure, Bioprene, Pumpsil and Marprene are trademarks of Watson-Marlow Limited. STA-PURE PFL® and STA-PURE PCS® are registered trademarks of W.L Gore & Associates Inc. Please state the product code when ordering pumps and tubing.

wmfts.com/global



26 July 2023