

ISSUE	DESCRIPTION	DATE
B	RIBS REMOVED	22/10/07

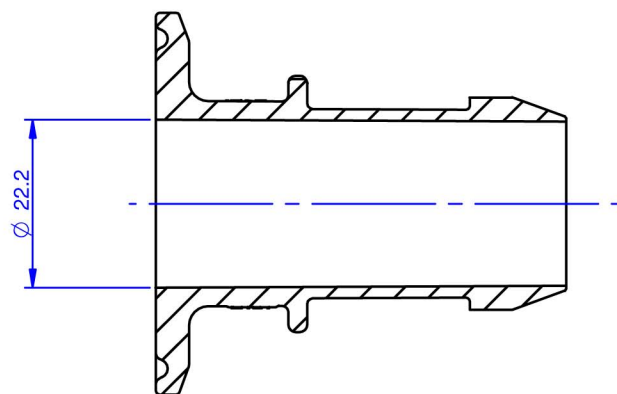

SECTION A-A

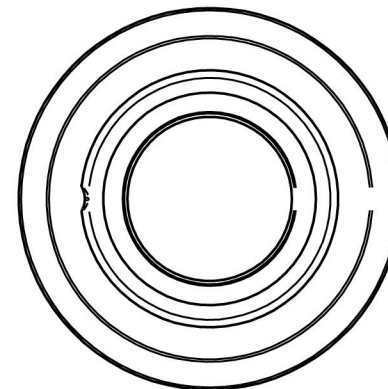
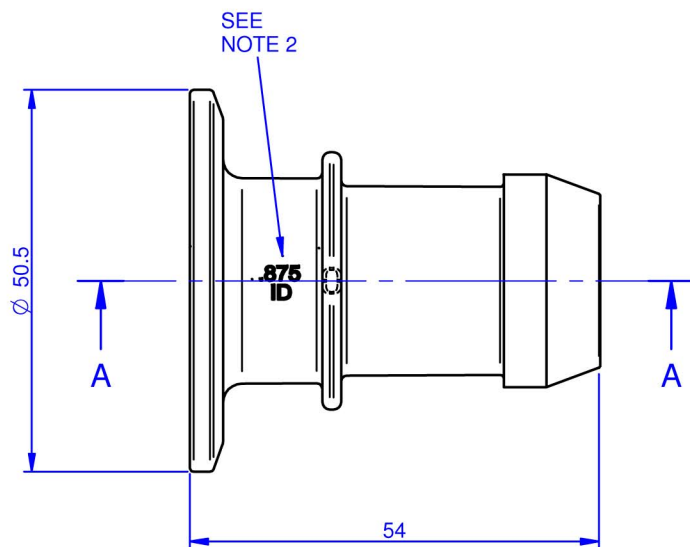
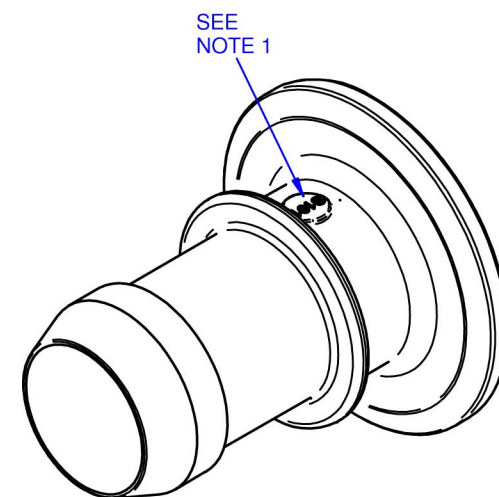

NOTES:

1. BATCH CODE TO BE MOULDED ON PART IN THIS AREA.
2. COMPONENT SIZE IDENTIFICATION TO MOULDED IN THIS POSITION.
3. NO FLASH OR IMPERFECTIONS PERMISSABLE ON FRONT EDGE OF BARB.
4. PART TO BE MANUFACTURED IN CLEANROOM ENVIRONMENT.
5. FLANGE DETAIL TO CONFORM TO RELEVANT ISO, BS & DIN STANDARDS

© COPYRIGHT

This drawing and its associated design is the property of Bio-Pure Technology Ltd & may not be copied or used for any purpose other than that for which it is supplied, without the express written authority of Bio-Pure Technology Ltd

DIMENSIONS IN MILLIMETERS

TOLERANCES UNLESS STATED
 0 DEC PLACE +/- 0.5
 1 DEC PLACE +/- 0.25
 2 DEC PLACES +/- 0.10

ANGULAR +/- 0.5 DEG

MATERIAL AND SPECIFICATION

PP Natural
 Borealis HD810MO

DRAWN BY

MJF

CHECKED BY

PJR

DATE

22/10/07

APPROVED BY

RM

FINISH

CLEAN

SCALE

1:1



BioPure Technology Ltd,

Unit M1, Hazleton Interchange,
 Lakesmere Road, Horndean, PO8 9JU.
 Tel: +44 (0) 2392 499000
 Fax: +44 (0) 2392 499001
 Email: sales@biopuretech.com
 Web: www.biopuretech.com

TITLE

BIOBARB
 LARGE FLANGE x 0.875

PART No:

PP100/150TC0875BB