

Pulsation damper series

PD/40, PD/65 and PD/100

Manual



ORIGINAL INSTRUCTIONS

© 2020 Watson-Marlow Bredel B.V.

All rights reserved.

The information provided herein may not be reproduced and/or published in any form, by print, photo print, microfilm or any other means whatsoever (electronically or mechanically) without the prior written authorization of Watson-Marlow Bredel B.V.

The information provided can be changed without prior notification. Watson-Marlow Bredel B.V. or one of its representatives cannot be held liable for possible damage resulting from use of this manual. This is an extensive limitation of the liability which applies to all damage, inclusive of (without limitation) compensating, direct, indirect or consequential damage, loss of data, income or profit, loss or damage to possessions and claims of third parties.

Watson-Marlow Bredel B.V. provides the information in this manual “as is” and does not take any responsibility and does not give any guarantee on this manual or its content. Watson-Marlow Bredel B.V. rejects all responsibilities and guarantees. Furthermore, Watson-Marlow Bredel B.V. does not take responsibility for and does not guarantee that information in this manual is accurate, complete or up to date.

Names, trade names, brands, etc. used by Watson-Marlow Bredel B.V. may not, as per the legislation concerning the protection of trade names, be considered as available.

CONTENTS

CONTENTS	3
1 GENERAL	4
1.1 <i>How to use this manual</i>	4
1.2 <i>Original instructions</i>	4
1.3 <i>Service and support</i>	4
1.4 <i>Environment and disposal of waste</i>	4
2 SAFETY	5
2.1 <i>Symbols</i>	5
2.2 <i>Intended use</i>	5
2.3 <i>Compliance Pressure Equipment Directive</i>	5
2.4 <i>Use In Potentially Explosive Environments (ATEX)</i>	5
2.5 <i>Responsibility</i>	6
2.6 <i>Qualification of the user</i>	6
2.7 <i>Regulations and instructions</i>	6
3 WARRANTY CONDITIONS	7
4 DESCRIPTION	8
4.1 <i>Identification of the product</i>	8
4.2 <i>Operation of the pulsation damper</i>	8
4.3 <i>Pulsation damper hose</i>	9
4.4 <i>Pulsation damper selection</i>	10
5 INSTALLATION AND COMMISSIONING	11
5.1 <i>Unpacking</i>	11
5.2 <i>Inspection</i>	11
5.3 <i>Installation conditions</i>	11
5.3.1 <i>Ambient conditions</i>	11
5.3.2 <i>Set-up</i>	11
5.4 <i>Lifting and moving the pulsation damper</i>	12
5.5 <i>Setting the pulsation damper pressure level for operation</i>	12
6 MAINTENANCE	14
6.1 <i>Cleaning the pulsation damper hose internally</i>	14
6.2 <i>Removing the pulsation damper hose</i>	14
6.3 <i>Replacing the pulsation damper hose</i>	15
6.4 <i>Checking the Pressure relief valve</i>	16
7 TROUBLESHOOTING	17
8 SPECIFICATIONS	18
8.1 <i>General information</i>	18
8.2 <i>Torque values</i>	18
8.3 <i>Weights</i>	19
8.4 <i>Dimensions</i>	19
8.5 <i>Spares list</i>	20
1.2 <i>Surface treatment</i>	21
9 DECLARATION OF INCORPORATION OF PARTLY COMPLETED MACHINERY	22
10 SAFETY FORM	23

1 GENERAL

1.1 How to use this manual

This manual is intended as a reference book by means of which qualified users are able to install, commission, operate and maintain the pulsation dampers mentioned on the front cover.

1.2 Original instructions

The original instructions for this manual have been written in English. Other language versions of this manual are a translation of the original instructions.

1.3 Service and support

For information with respect to specific adjustments, installation, maintenance or repair jobs which fall beyond the scope of this manual, contact your Bredel representative. Make sure you have the following information at hand:

- serial number pulsation damper
- type number pulsation damper

You will find this data on the identification plate of the pulsation damper (see paragraph *4.1 Identification of the product*).

1.4 Environment and disposal of waste







Enquire within your local government about the possibilities for reuse or environment friendly processing of packaging materials, (contaminated) lubricant and oil.

Always observe the local rules and regulations with respect to processing (non-reusable) parts of the pulsation damper

2 SAFETY

2.1 Symbols

In this manual the following symbols are used:

	<p>WARNING Procedures which, if not carried out with the necessary care, may result in serious damage to the pulsation damper or in serious bodily harm.</p>
	<p>CAUTION Procedures which, if not carried out with the necessary care, may result in serious damage to the pulsation damper, the surrounding area or the environment.</p>
	<p>Remarks, suggestions and advice.</p>
	<p>Procedures, remarks, suggestions or advise which refer to use in potentially explosive atmospheres (ATEX) in accordance with European guideline 2014/34/EU.</p>

2.2 Intended use

The pulsation damper is exclusively designed for the damping of pulses on the discharge side of a Bredel hose pump. After consultation with your Bredel representative, and only on certain conditions, the pulsation damper may be used as a pressure relief valve. Every other or further use is not in conformance with the intended use¹. The manufacturer cannot be held responsible for any damage or harm resulting from this. The pulsation damper is designed in conformance with the current European standards and directives. Only use the pulsation damper in conformance with the intended use described above. If you want to change the application of your pulsation damper, contact your Bredel representative first.

¹ The "intended use" as laid down in NEN-EN-ISO 12100 is "...the use for which the technical product is intended in accordance with the specifications of the manufacturer, inclusive of his indications in the sales brochure". In case of doubt it is the use which appears to be its intended use judging from the construction, execution and function of the product. Observing the instructions in the user's documentation also belongs to intended use.

2.3 Compliance Pressure Equipment Directive

The pulsation dampers as mentioned on the front cover are in full compliance with the European Pressure Equipment Directive 2014/68/EU.

2.4 Use In Potentially Explosive Environments (ATEX)

The pulsation dampers PD/40, PD/65 and PD/100 can be used in a potentially explosive atmosphere (ATEX). The pulsation damper is not classed as ATEX equipment since it contains no ignition source

from its own. It is considered as part of the pump and the ATEX code for the pump is applicable, meaning it can operate under the same ATEX environment as the pump it is attached to. In general this means the damper is suitable for Group II, category 2 and temperature class T4.

When operating under ATEX pay extra attention to the following:

- Pulsation Damper to be installed, operated and maintained according this manual (see chapter 8 *SPECIFICATIONS*).
- Make sure the damper is connected to the earth. In general this is the case when the damper is connected to the pump and the piping system. By construction all parts are electrically connected. This can be checked by measuring the electrical resistance to the earth. The electrical resistance to any ground connection should be less than 1 MOhm.



WARNING

In case it is not possible to create an earth/ground connection with less than 1 MOhm, one should make an additional PE (protective earth) connection to the pulsation damper. (see chapter 5 *INSTALLATION AND COMMISSIONING*).

2.5 Responsibility

The manufacturer does not accept any responsibility for damage or harm caused by not (strictly) observing the safety regulations and instructions in this manual or by negligence during installation, use, maintenance and repair of the pulsation dampers mentioned on the front cover. Depending on the specific working conditions or accessories used, additional safety instructions can be required. Immediately contact your Bredel representative, if you notice a potential danger while using your pulsation damper.



WARNING

The user of the pulsation damper is always fully responsible for observing the local valid safety regulations and directives. Observe these safety regulations and directives when using the pulsation damper.

2.6 Qualification of the user

The installation, operation and maintenance of the pulsation damper should be carried out by well trained and qualified users. Temporary staff and persons in training may only use the pulsation damper under the supervision and responsibility of well trained and qualified users.

2.7 Regulations and instructions

- Everyone who works with the pulsation damper must be aware of the content of this manual and observe the instructions with great care.
- Never change the order of the actions to be carried out.
- Always store the manual near the pulsation damper.

3 WARRANTY CONDITIONS

The manufacturer offers a two year warranty on all parts of the pulsation damper. This means that all parts will be repaired or replaced free of charge with the exception of consumables, such as hoses and seals, or parts which have been misused or have been intentionally damaged. If parts are used that are not Watson-Marlow Bredel B.V. (hereafter called Bredel) parts, every warranty becomes void.

Damaged parts which are covered by the applicable warranty conditions can be returned to the manufacturer. The parts must be accompanied by a fully filled in and signed safety form, as present in the back of this manual. The safety form must be applied to the outside of the shipping carton. Parts which have been contaminated or which have been corroded by chemicals or other substances which can pose a health risk, must be cleaned before they are returned to the manufacturer. Furthermore, it should be indicated on the safety form which specific cleaning procedure has been followed, and it should be indicated that the equipment has been decontaminated. The safety form is required at all items, even if the parts have not been used.

Warranties purporting to be on behalf of Bredel B.V. made by any person, including representatives of Bredel, its subsidiaries, or its distributors, which do not accord with the terms of this warranty shall not be binding upon Bredel unless expressly approved in writing by a Director or Manager of Bredel.

4 DESCRIPTION

4.1 Identification of the product

The pulsation damper and pulsation damper hose can be identified by the contents of the identification plate on the pulsation damper housing and the hose label.

The identification plate of the pulsation damper contains the following information, relevant for identification:

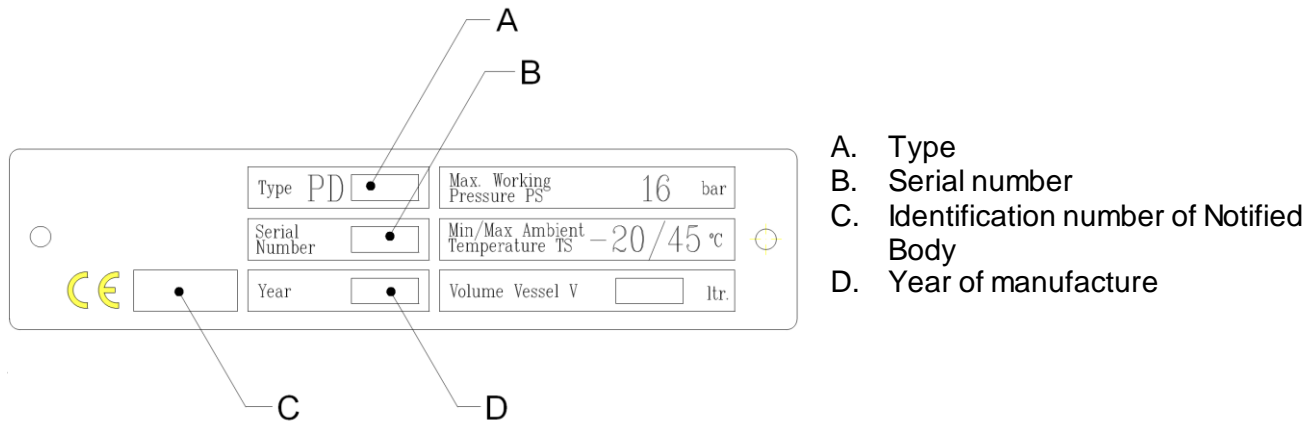

The hose label on the pulsation damper hose contains following information:

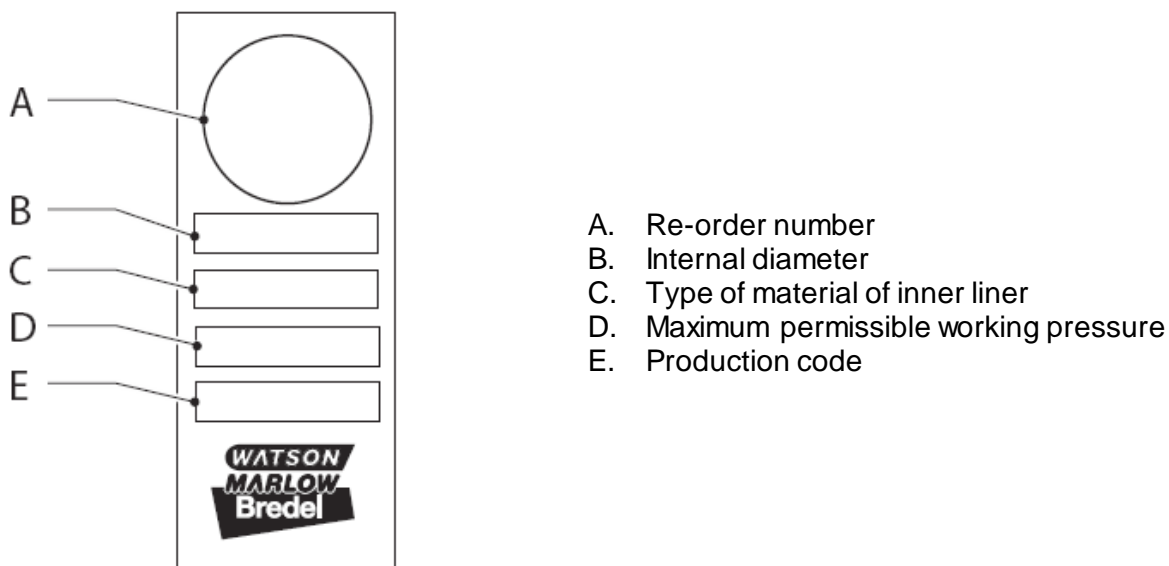

4.2 Operation of the pulsation damper

The Bredel pulsation damper reduces the pulses created in the discharge line by the hose pump. This is achieved by means of a thick-walled, reinforced rubber hose which is mounted in a carbon steel, cylindrical pressure vessel. The hose is surrounded by compressed gas (air or nitrogen).

When a pressing shoe leaves the pump hose, while rotating, instantly the volume in the discharge line will increase with the volume of the pump hose now released by the pressing shoe. This will result in a momentary deceleration of the fluid which results in a pressure drop in the discharge line.

When the discharge pressure drops, the pulsation damper hose contracts and compensates for the released volume of the pressing shoe in the discharge line. The fluid deceleration is minimised and the pulse will be reduced.

Depending on the application and size the damper can reduce the pulse by 50-90%. The damper is most effective at a discharge pressure of 500 kPa or above. The pulsation dampers can be pressurized up to 1600 kPa. The pulsation dampers are safeguarded for over-pressure by a pressure-relief valve.

4.3 Pulsation damper hose

The pulsation damper hose liner material should be chemically resistant to the product to be pumped. Dependent on the specific requirements of your application, a matching hose should be selected.

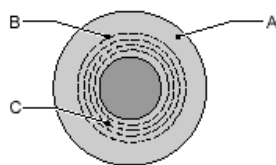

- A. Outer extruded layer made of natural rubber
- B. Four nylon reinforcement layers
- C. Inner extruded liner

For each pulsation damper, various hose types are available. The material of the inner liner of the hose determines the hose type. Each hose type is marked by a unique colour code.

Hose type	Material	Colour code	Article number:		
			PD/40	PD/65	PD/100
NR	Natural rubber	Purple	P040020	P065020	P100020
NBR	Nitrile rubber	Yellow	P040040	P065040	P100040
EPDM	EPDM	Red	P040075	P065075	P100075

	<p>Consult your Bredel representative for Hose Pumps for more detailed information about the chemical and temperature resistance of pulsation damper hoses.</p>
---	---

	<p>Store the pulsation damper hose in a cool, dry place and do not subject it to sunlight.</p>
---	--

4.4 Pulsation damper selection

The pulsation damper types mentioned on the front cover are functional with more than one type of Bredel hose pumps. In the following table the right pulsation damper can be selected to match your hose pump:

Selection table pump and pulsation damper	
Pulsation damper type:	Pump type:
PD/40	Bredel 25, Bredel 32, Bredel 40
PD/65	Bredel 50, Bredel 65
PD/100	Bredel 80, Bredel 100



If you are in doubt about the correct installation of your pulsation damper, contact your Bredel representative for assistance. They will advise about the installation layout, pipe diameters, etc., to ensure optimum performance of your pulsation damper.

5 INSTALLATION AND COMMISSIONING

5.1 Unpacking

When unpacking carefully follow the instructions as given on the packaging or on the pulsation damper.

5.2 Inspection

Check that your delivery is correct and check it for any transport damage (see also paragraph 4.1 *Identification of the product*).

5.3 Installation conditions

5.3.1 Ambient conditions

Make sure the ambient temperature, during normal operation of the pulsation damper, does not fall to below -20°C , and does not exceed $+45^{\circ}\text{C}$.

5.3.2 Set-up

When installing the pulsation damper consider the following points:

- The pulsation damper will not be effective for variable pump speeds or variable discharge pressures.
- Limit the presence of sharp bends. Make sure that the radius of the bent discharge line is as large as possible. It is recommended to use Y-connections instead of T-connections.
- The pulsation damper will be most effective if it is directly mounted onto the hose pump. Minimise the distance between pump and pulsation damper.
- The pulsation damper may be installed in either the horizontal or vertical position.
- The pulsation damper must be suitably supported.
- The pulsation damper must be electrically connected to earth. (Resistance less than 1 MOhm). If required make a PE connection to the pulsation damper. The PE wire can be connected to one of the bolts attaching the flange bracket to the damper housing.



If installed in a potentially explosive atmospheres, properly earth the pulsation damper and respect the instructions as mentioned in paragraph 2.4 *Use In Potentially Explosive Environments (ATEX)*

- Avoid, at all times, a pressure higher than the maximum operating pressure.
- When using a Bredel series 265-2100 pump with pulsations over 500 kPa (5 bar, 72.5 psi) use two pulsation dampers - one for each pump head.

- Avoid too heavy loads on the flanges. The maximum forces are given in the table below:

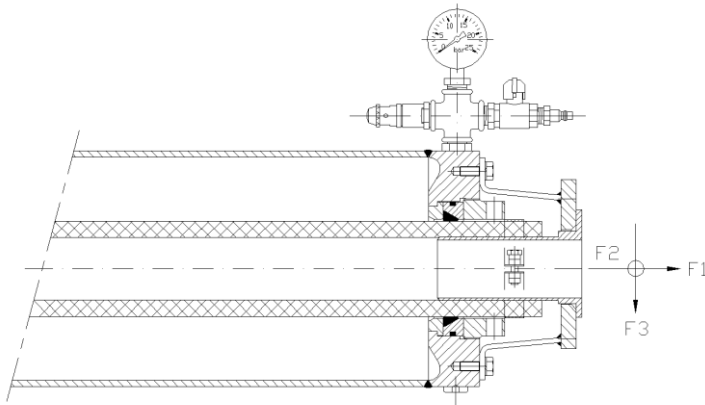

Maximum flange loads				
Force	Unit	PD/40	PD/65	PD/100
F1	N	1000	1400	2000
	lbf	225	315	450
F2	N	500	700	1000
	lbf	112	157	225
F3	N	200	300	400
	lbf	45	67	90

5.4 Lifting and moving the pulsation damper

To lift, move and position the pulsation damper, suitable hoisting belts must be used. The best place to attach the hoisting belts is immediately behind both flanges of the pulsation damper. Keep in mind the pulsation damper's weight. For weights see also paragraph 8.3 *Weights*.



WARNING

If the pulsation damper is to be lifted, ensure that all safety regulations for lifting movements are adhered to and that the lifting is carried out by qualified personnel only.

5.5 Setting the pulsation damper pressure level for operation

The pulsation damper air or nitrogen pressure level must be set. This setting for maximum pulse reduction depends on the process condition. Therefore the setting can only be obtained when the pump is running at operating conditions.

It is advised to check the pressure relief valve functioning with each installation, hose replacement or annually (which comes first). (See paragraph 6.4 *Checking the Pressure relief valve*.)



CAUTION

Consider the maximum allowable pressure. The maximum allowable pressure can either be determined by the pulsation damper, pump or process. Exceeding the maximum allowable pressure may lead to serious injuries or damage to the pump and the environment.



CAUTION

Consider the filling medium for the pulsation damper housing – in this case **compressed air** or **nitrogen**. If in doubt concerning the correct filling medium for your pulsation damper, contact your Bredel representative for assistance.



CAUTION

Before pressurizing the pulsation damper ensure that the pulsation damper is built in the piping system, ensure that the suction and discharge valves are open, ensure that any drain valves are closed. (process released for operation)

1. Shut the ball valve (pos. 17) on the pulsation damper.
2. Connect the filling medium to the filling nipple (pos. 18).
3. Apply pressure to the pulsation damper by the filling medium. Minimum filling medium supply pressure should at least be equal to the process working pressure directly upstream of the pulsation damper.
4. Start the pump
5. Open the ball valve (pos. 17) gently. Filling medium will now enter and pressurize the vessel. Check the pressure gauge (pos. 20) for the actual gas pressure p_v inside the vessel.
6. Pressurize the vessel to approximately 80% of the actual fluid discharge pressure of the hose pump (p_2), close to the pulsation damper.
7. Continue to fill the vessel with gas and closely watch the pressure pulsation on the manometer. When the pulsation drops to a minimum the required gas pressure is reached. Shut off the ball valve (pos. 17). The pressure inside the vessel should be within the indicated range shown in the table below.

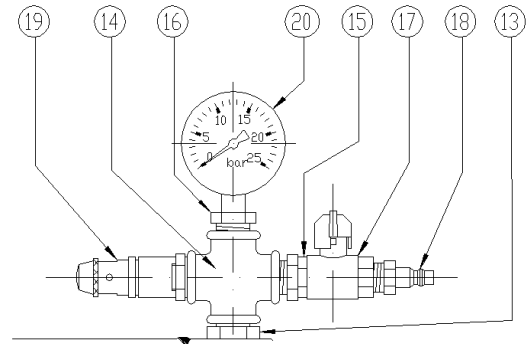

	Vessel gas pressure p_v (reading gauge pos. 20)
PD size 40	$p_2 < p_v < p_2 + 2 \text{ bar}$
PD size 65	$p_2 < p_v < p_2 + 1,5 \text{ bar}$
PD size 100	$p_2 < p_v < p_2 + 1 \text{ bar}$

The gas pressure p_v in the vessel must not exceed 16 bar.

8. Shut off the supply pressure of the filling medium



Caution

The optimum vessel pressure is process specific. It is advised to slowly increase the vessel pressure until the pressure fluctuations downstream of the pulsation damper are minimized and optimal damping is obtained. The gas pressure p_v must not exceed the design pressure p_s of 16 bar.



If the actual process working pressure is very low (for example during standstill or after a transfer cycle is completed) it is advised to relief the pressure from the pulsation damper.

6 Maintenance

Careful maintenance and, in particular, scrupulous cleaning are essential for problem-free operation of the pulsation damper.

- Before carrying out any maintenance to the pulsation damper, please thoroughly acquaint yourself with the directives in the chapter 2 *SAFETY*.
- Any repair to the pulsation damper is to be carried out by properly skilled and authorised users only.
- After cleaning and maintenance work, do not use the pulsation damper until all parts that have been removed, are reinstalled correctly.



WARNING

Release the pressure from the pulsation damper by means of the ball valve near the pressure-relief valve, before starting on any work to the pulsation damper.



WARNING

Protect your hands and face from any dangerous substances when handling or examining the pulsation damper hose.



CAUTION

After maintenance has been carried out, and before switching the pump back on, ensure that all valves present in the pipe work are opened.

6.1 Cleaning the pulsation damper hose internally

The inside of the pulsation damper hose is easily cleaned by flushing the pump and pulsation damper with clean water. If a cleaning fluid is added to the water, it must be checked that the hose liner material is resistant to that.



With many products to be pumped, it is necessary to clean the pulsation damper hose immediately once the pump is stopped, to avoid solidification and hardening of the product within the hose.

6.2 Removing the pulsation damper hose

1. Disconnect the electrical supply from the corresponding pump and close any valves to minimise product loss.
2. Position a tray under the pulsation damper. This tray must be sufficiently large to collect all liquid product inside the pulsation damper.
3. Release all pressure from the pulsation damper using the ball valve (pos. 17).



WARNING

If the pulsation damper hose is cracked or worn, liquid product to be pumped may escape via the ball valve (pos. 17). Therefore, take the necessary safety precautions.

4. Support the pulsation damper in such a way that it cannot fall during disassembly.
5. Remove the mounting bolts from both flanges. Lift the pulsation damper onto a suitable workbench. Adhere to the instructions for lifting and moving as mentioned in paragraph 5.4 *Lifting and moving the pulsation damper*.
6. Loosen the hose clamps (pos. 8) from both ends.
7. Unscrew the bolts (pos. 11 and 12) from both flanges (pos. 9).
8. Unscrew the locknut (pos. 7) on both sides until the compression on the pulsation damper hose has relieved.
9. Remove both inserts (pos. 10) from the pulsation damper hose.
10. Remove both metal rings (pos. 5 + 6), O-rings (pos. 4) and neck-rings (pos. 3)
11. Remove the mounting bolts from both flange supports (pos. 9) together with the inserts (pos. 10).
12. Remove the pulsation damper hose from the housing.

6.3 Replacing the pulsation damper hose

After the pulsation damper hose has been removed, as described in “Removing the pulsation damper hose”, the (new) hose can be installed in the pulsation damper.



CAUTION

If you are installing a new pulsation damper hose, and you wish to continue pumping the same product, ensure that the colour code of the new hose matches the colour code of the old, used hose.

1. Check all parts to be installed for any damage and replace when necessary.
2. Grease all metal parts which are not corrosion-protected and O-rings with Molykote® 55M or equivalent.
3. Place one of the collar bushes (pos. 3) in the damper housing. Install the pulsation damper hose (pos. 2). Place the second collar bush (pos. 3).
4. Slide both O-rings (pos. 4) at both ends over the pulsation damper hose.
5. Place both metal rings (pos. 5 + 6) and hand-tighten both pressing rings (pos. 7).
6. Loosely place the hose clamps (pos. 8) at both ends.
7. Loosely place the flanges on both sides (pos. 9) and place the inserts. (pos. 10)
8. Tighten the pressing rings (pos. 7) (see also paragraph 8.2 *Torque values*).
9. Tighten both flanges (pos. 9) using the corresponding bolts and spring washers. (pos. 11 and 12)
10. Lift the pulsation damper from the work bench and place it back into the pipe work. Observe the instructions for lifting and moving as mentioned in paragraph 5.4 *Lifting and moving the pulsation damper*. Mount and tighten the mounting bolts to the flanges at both ends.
11. Shut the ball valve (pos. 17) on the pulsation damper.
12. Connect the filling medium to the filling nipple.
13. Apply pressure to the pulsation damper by the filling medium.
14. Open the ball valve (pos. 17) gently. Filling medium will now enter and pressurize the vessel. Check the pressure gauge (pos. 20) for the actual pressure inside the vessel.

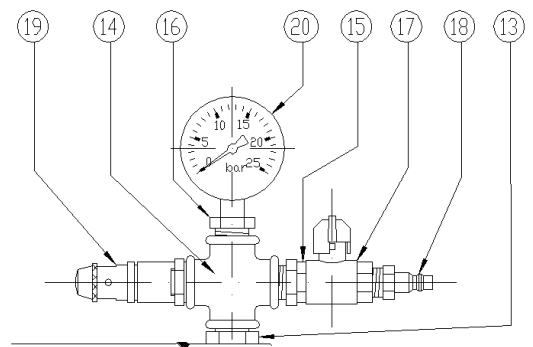

15. Pressurize the vessel to 1400 kPa (14 bar, 203 psi) above atmospheric. By pressurizing the hose will be stretched outwards, forcing the hose ends over the inserts.
16. Close the ball valve.
17. Tighten both hose clamps (pos. 8) with the proper torque values.



The minimum required torque values as advised (see paragraph 8.2 *Torque values*) cannot always be realized in the field. This is due to the unknown friction between tightening bolt and clamp. Especially in case of used stainless steel clamps that are not properly greased. In such case the applied bolting torque does not reflect the required clamping force of the hose clamp.

So in case the minimum specified torque values are not sufficient it is advised to increase the bolt torque until a sealed situation is obtained. Here the absolute torque value is of less importance (although maximum applied bolting torques should remain within the range specified (see paragraph 8.2 *Torque values*). It is advised to tighten the clamp until the outside diameter of the clamp is between 0 to 2 mm (0 to 0.08 inch) below the outside diameter of the PD hose in unclamped condition.

		PD/40	PD/65	PD/100
Advised Clamp OD	[mm]	69 – 71	98 – 100	138 – 140
	[inch]	2.72 – 2.80	3.86 – 3.94	5.43 – 5.51



The complete PD hose replacement procedure can also be done with the PD outside the piping system, provided that the inserts are locked by installing an additional flange on both sides of the pulsation damper flanges and external gas pressure (up to 1600 kPa, 16 bar, 232 psi above atmospheric) can be applied.

6.4 Checking the Pressure relief valve

It is advised to check the pressure relief valve functioning with each installation, hose replacement or annually (which comes first).

1. Check all parts to be installed for any damage and replace when necessary.
2. Make sure the pulsation damper is fully assembled and installed in the process piping. (If testing is done with a standalone pulsation damper the inserts should be blocked by fitting additional flanges on both flanges of the pulsation damper.)
3. Apply pressure to the pulsation damper by carefully opening the ball valve. The procedure for applying the pressure is described in the paragraph “Setting the pulsation damper pressure level for operation”.
4. Above 1600 kPa (16 bar, 232 psi), the pressure relief valve should open, keeping the pressure from rising further. The proofs the relief valve is fit for duty.



CAUTION

Do not pressurize the pulsation damper if the inserts are not secured. Securing the insert can be done by installing an additional flange on both flanges of the pulsation damper or by installing the pulsation damper into the pipe system.



CAUTION

If you want to check the function of the pressure-relief valve, apply pressure to the vessel of 1600 kPa (16 bar, 232 psi). The valve should automatically open. Relieve the pressure. Replace the pressure-relief valve if it does not open before reaching 1700 kPa (17 bar, 246 psi) pressure

7 TROUBLESHOOTING

If the pulsation damper does not function (correctly), consult the following checklist to see if you can remedy the problem yourself. If you cannot, please contact your Bredel representative.

Problem	Possible cause	Solution
(Heavy) vibration of Pump, Pulsation damper or pipework	Pressure inside vessel too low	Pressurize the vessel of pulsation damper again according paragraph <i>5.5 Setting the pulsation damper pressure level for operation.</i>
	Pressure inside vessel too high	
Product leakage	Not all parts have been greased properly.	Grease all necessary parts. See also paragraph <i>6.3 Replacing the pulsation damper hose.</i>
Pressure loss at pulsation damper housing	Damaged O-ring (pos. 4 or 5)	Replace the O-ring concerned.
	Pressing ring (pos. 7) incorrectly mounted	Tighten to the specified torque settings (see paragraph <i>8.2 Torque values</i>)
Short pulsation damper hose life	Chemical corrosion of the hose	Check the compatibility of the hose material with the product to be pumped. Consult your Bredel representative for correct hose selection.
	High discharge pressures	Maximum operating pressure is 1600 kPa. Check whether the discharge line is blocked. Make sure the shut-off valves are fully opened and the pressure-relief valve (if present) in the discharge line is functioning properly.
	High product temperature	Consult your Bredel representative for correct pulsation damper hose selection.
	High pulsations	Restructure the discharge and inlet conditions.

8 SPECIFICATIONS

8.1 General information

Description	Value	
Maximum allowable working pressure (p_s)	1600 kPa	232 psi
Allowable ambient temperature	-20 to +45 °C	-4 to +113 °F
Allowable product temperature	-10 to +80 °C	+14 to +176 °F
Allowable storage temperature	-40 to +70 °C	-40 to +158 °F
Maximum surface temperature	+90 °C (T5)	+194 °F (T5)
Air volume vessel	See: identification plate	

8.2 Torque values

Component	Description	Unit	PD/40	PD/65	PD/100
Pressing ring (pos. 7)	Thread		M115 x 2	M145 x 2	M185 x 3
	Torque value		N/A	N/A	N/A
	Toolbar diameter	mm	Ø16	Ø16	Ø16
		inch	Ø0.63	Ø0.63	Ø0.63
Hose clamp (pos. 8)	Thread		M8	M8	M10
	Torque value ¹⁾	Nm	12 - 25	15 - 35	15 - 35
		lbf in	106 - 220	133 - 310	133 - 310
	Key width	mm	13	13	17
		inch	0.51	0.51	0.67
Connecting flange (pos. 11)	Thread		M8	M10	M12
	Torque value	Nm	25	50	85
		lbf in	220	440	750
	Key width	mm	13	17	19
		inch	0.51	0.67	0.75

1) Minimum torque value based on new clamps with smooth thread.

See also chapter 6.3 *Replacing the pulsation damper hose* point 17 for extra instruction on hose clamp installation.

8.3 Weights

Description	Unit	PD/40	PD/65	PD/100
Pulsation damper, complete	kg	32	75	135
	lbs	70.5	165	297
Hose	kg	2.2	4.9	11
	lbs	4.9	10.8	24.2

8.4 Dimensions

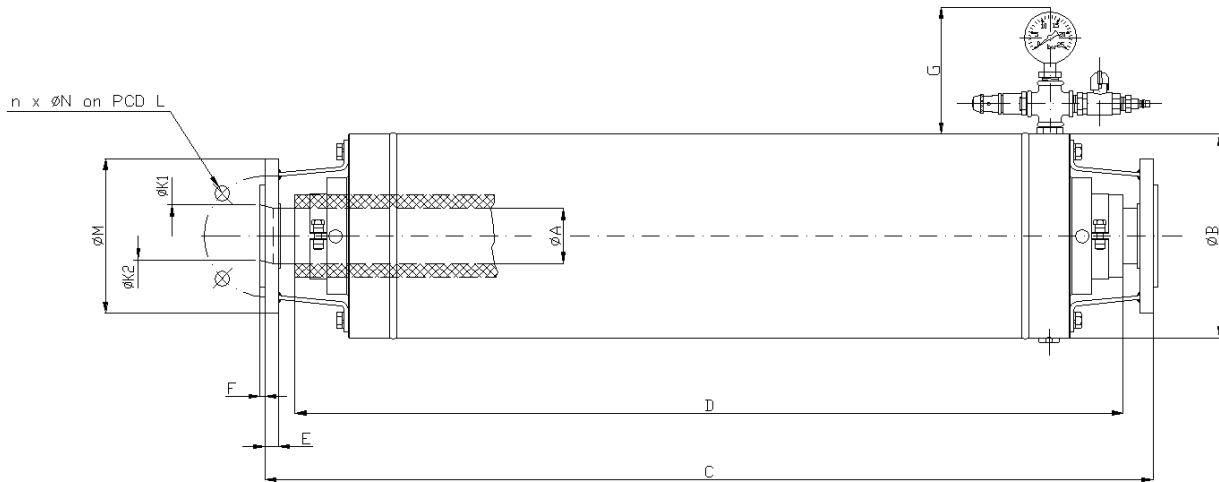

Dimensions in [mm]

Damper Type	Pump Type	A	B	C	D	E	F			G	K1	K2	n	L	M	N
							Steel	SS	Non-Ferro							
PD/40	Bredel 25	40	168	800	735	16	-	4	20	175	-	25	4	85	115	14
	Bredel 32					18		4			32	100		140	18	
	Bredel 40					18		2.5			-	110		150		
PD/65	Bredel 50	65	245	1050	975	19	-	6	20	175	-	50	4	125	165	18
	Bredel 65					20	6	3			65	-		8	145	
PD/100	Bredel 80	100	324	1356	1295	20	8	8	48	175	-	80	8	160	200	18
	Bredel 100					22		3			100	-		180	220	

Dimensions in [inch]

Damper Type	Pump Type	A	B	C	D	E	F			G	K1	K2	n	L	M	N
							Steel	SS	Non-Ferro							
PD/40	Bredel 25	1.57	6.61	31.50	28.94	0.63	-	0.16	0.79	6.89	-	0.98	0.16	3.35	4.53	0.55
	Bredel 32					0.71		0.16			1.26	3.94		5.51	0.71	
	Bredel 40					0.71		0.10			-	4.33		5.91		
PD/65	Bredel 50	2.56	9.65	41.34	38.39	0.75	-	0.24	0.79	6.89	-	1.97	0.16	4.92	6.50	0.71
	Bredel 65					0.79	0.24	0.12			2.56	-		0.31	5.71	
PD/100	Bredel 80	3.94	12.76	53.39	50.98	0.79	0.31	0.31	1.89	6.89	-	3.15	0.31	6.30	7.87	0.71
	Bredel 100					0.87		0.12			3.94	-		7.09	8.66	

8.5 Spares list

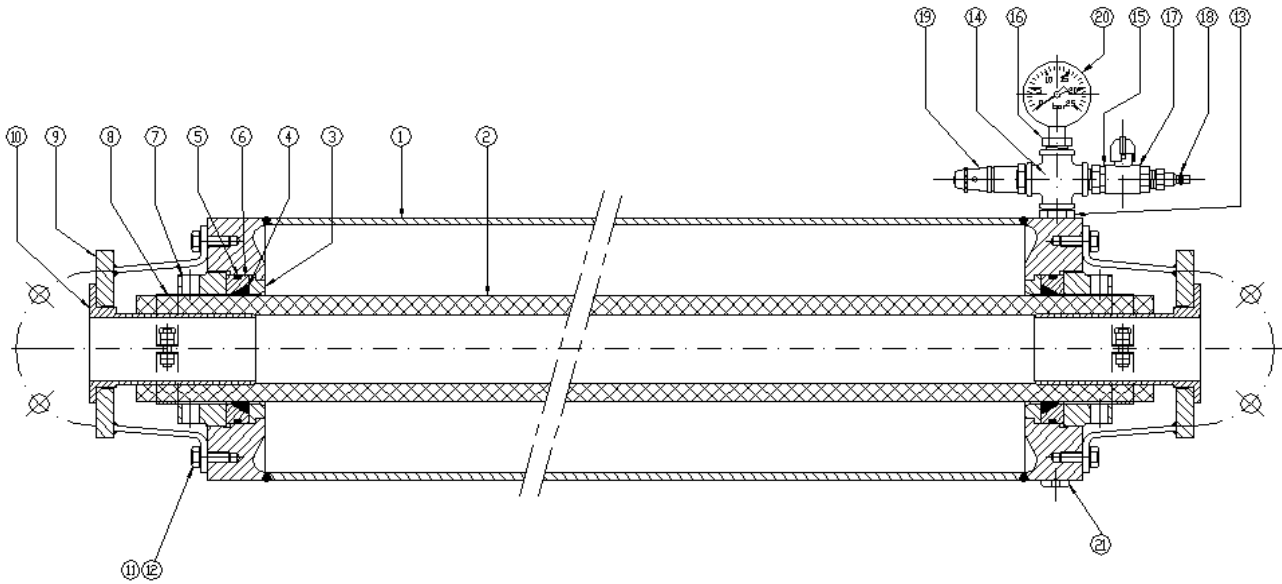

Pos.	Qty.	Description	PD/40	PD/65	PD/100
1	1	Housing	P040202	P065202	P100202
2	1	Hose NR	P040020	P065020	P100020
	1	Hose NBR	P040040	P065040	P100040
	1	Hose EPDM	P040075	P065075	P100075
3	2	Collar bush	P040204	P065204	P100204
4	2	O-ring NBR	S110701	S111001	S111351
5	2	O-ring NBR	S123451	S123541	S123641
6	2	Metal ring	P040206NS	P065206NS	P100206NS
7	2	Pressing ring	P040207	P065207	P100207
8	2	Hose clamp	C122007	C122014	C101054
9	2	Flange, steel, EN 40-25	P040213		
	2	Flange, steel, EN 40-32	P040293		
	2	Flange, steel, EN 40-40	P040209		
	2	Flange, steel, EN 65-50		P065213	
	2	Flange, steel, EN 65-65		P065209	
	2	Flange, steel, EN 80-100			P100213
	2	Flange, steel, EN100-100			P100209
	2	Flange, steel, ASA 40-25	P040271		
	2	Flange, steel, ASA 40-32	P040272		
	2	Flange, steel, ASA 40-40	P040273		
	2	Flange, steel, ASA 65-50		P065271	
	2	Flange, steel, ASA 65-65		P065273	
	2	Flange, steel, ASA 80-100			P100271
	2	Flange, steel, ASA100-100			P100273
	2	Flange, steel, JIS 40-25	P040277		
	2	Flange, steel, JIS 40-32	P040278		
	2	Flange, steel, JIS 40-40	P040279		
2	Flange, steel, JIS 65-50		P065277		
2	Flange, steel, JIS 65-65		P065279		
2	Flange, steel, JIS 80-100			P100277	
2	Flange, steel, JIS100-100			P100279	
10	2	Insert, SS PD40-25	P040215		
	2	Insert, PVC PD40-25	P040216		

Pos.	Qty.	Description	PD/40	PD/65	PD/100
	2	Insert, PP PD40-25	P040290		
	2	Insert, PVDF 40-25	P040280		
	2	Insert, SS PD 40-32	P040295		
	2	Insert, PVC PD 40-32	P040296		
	2	Insert, PP PD 40-32	P040291		
	2	Insert, PVDF 40-32	P040281		
	2	Insert, SS PD 40-40	P040211		
	2	Insert, PVC PD 40-40	P040212		
	2	Insert, PP PD40-40	P040292		
	2	Insert, PVDF PD40-40	P040282		
	2	Insert, SS PD 65-50		P065215	
	2	Insert, PVC PD 65-50		P065216	
	2	Insert, PP PD 65-50		P065290	
	2	Insert, PVDF 65-50		P065280	
	2	Insert, Steel PD 65-65		P065210	
	2	Insert, SS PD 65-65		P065211	
	2	Insert, PVC PD 65-65		P065212	
	2	Insert, PP PD 65-65		P065292	
	2	Insert, PVDF 65-65		P065282	
	2	Insert, Steel PD 100-80			P100214
	2	Insert, SS PD 100-80			P100215
	2	Insert, PVC PD 100-80			P100216
	2	Insert, PP PD 100-80			P100290
	2	Insert, PVDF 100-80			P100280
	2	Insert, Steel PD 100-100			P100210
	2	Insert, SS PD 100-100			P100211
	2	Insert, PVC PD 100-100			P100212
	2	Insert, PP PD 100-100			P100292
	2	Insert, PVDF 100-100			P100282
11	8	Bolt M8 x 20	F111071		
	8	Bolt M10 x 25		F111096	
	8	Bolt M12 x 30			F111130
12	8	Washer M8, Spring Lock	F336011		
	8	Washer M10, Spring Lock		F336012	
	8	Washer M12, Spring Lock			F336013
13	1	Nipple	A132511	A121004	A121004
14	1	Cross piece G1/2"	A123003	A123003	A123003
15	1	Reducing ring G1/2"x 3/8"	A122006	A122006	A122006
16	1	Reducing ring G1/2"x 1/4"	A122005	A122005	A122005
17	1	Ball valve G3/8"	A106002	A106002	A106002
18	1	Nipple G3/8"	A125005	A125005	A125005
19	1	Safety valve G1/2"	A210003	A210003	A210003
20	1	Pressure gauge 0-25 bar	A220001	A220001	A220001
21	1	Stop	A124514	A124516	A124516

1.2 Surface treatment

- After surface preparation, one layer of two-component acrylate is used for surface protection. Standard color is RAL 3011, however other colors are optional. Contact your Bredel representative for details on surface treatment.
- All galvanized parts, excluding fasteners, will have an electrolytic zinc layer of 15-20 microns.

9 DECLARATION OF INCORPORATION OF PARTLY COMPLETED MACHINERY

We,
Watson Marlow Bredel B.V. herewith declare, on our own responsibility, that the following partly completed machinery

description: Pulsation damper for hose pumps
type/model PD/40, PD/65 and PD/100

serial number(s): _____

to which this declaration applies, complies with the essential requirements of:

- the European pressure equipment directive 2014/68/EU (PED).
- the European machine directive 2006/42/EC, annex II.1.B

The following essential requirements of Annex 1 are applied and fulfilled:

1.1.2, 1.1.5, 1.3.1, 1.3.2, 1.3.4, 1.3.6, 1.5.2, 1.5.7, 1.5.9, 1.5.13, 1.6.1, 1.6.2, 1.6.5, 1.7.1, 1.7.1.1, 1.7.3, 1.7.4, 1.7.4.1, 1.7.4.2, 1.7.4.3.

The products as mentioned above comply to fluid classification group I (dangerous fluids) and were subjected to the conformity assessment procedure as mentioned in the table below. Type examination (module B) has been in conformity with AD 2000 Edition 2002.

Type	Module(s)	Cat.
PD/40	A2	II
PD/65	B + C2	III
PD/100	B + C2	III

The monitoring of the products is performed by Lloyd's Register Verification, London, United Kingdom. Lloyd's Register is a registered body notified under directive 2014/68/EU Pressure Equipment under identification number: 0343.

The monitoring of the manufacturer's quality assurance system is performed by BSI Group Netherlands, located in Amsterdam, the Netherlands.

When this pulsation damper is to be installed into a machine or is to be assembled with other machines for installations, it is not be put into service until the relevant machinery has been declared in conformity with these guidelines.

J. van den Heuvel,
Managing Director



Delden, January 2020

Watson-Marlow Bredel B.V.
Sluisstraat 7, 7491GA Delden, The Netherlands,

10 SAFETY FORM



WARNING

A complaint will only be handled by Bredel if this Safety Form is fully completed and digitally send to Bredel before shipment is activated. A hardcopy of this form is to be attached to the outside of the packaging including MSDS sheet or similar safety information sheet if applicable for each item returned.

Product Use and Decontamination Declaration

In compliance with our **Health & Safety Regulations**, the user is required to declare any substances that have been in contact with the item(s) being returned to Watson-Marlow Bredel B.V. or any of its subsidiaries or distributors. Not following these requirements may lead to delays in service and/ or response time. Full completion of this form assures we are provided with necessary information before receipt of the item(s) being returned. A hardcopy of the completed form must be attached to **the outside of the packaging** containing the item(s). The sender of the item(s) is responsible for cleaning and decontaminating of the item(s) before returning them in such way that it is safe for the receiver to open the packaging and handle the item(s).

Complaint number:

1. Company:
 Address: Postal code:
 Contact person: Email address:
 Telephone: Fax number:

2. Product:

2.1 Serial Number:.....

2.2 Has the Product been used?

Yes (Go to section 3)

No (Go to section 5)

3. Details of substances pumped

3.1 Chemicals names:

(a)

(b)

(c)

(d)

3.2 Precautions to be taken in handling these substances:

(a)

(b)

(c)

(d)

3.3 Actions to be taken in event of human contact:

(a)

(b)

(c)

(d)

3.4 Cleaning fluid to be used if residue of chemical is found during service:

(a)

(b)

(c)

(d)

4. I hereby confirm that the only substance(s) that the equipment specified has pumped or come into contact with those named, that the information given is correct and the carrier has been informed if the consignment is of a hazardous nature.

5. Signed:

Name:

Position:

Date:

Note:

To assist us in our service, please describe any fault condition you have witnessed.

.....

.....

.....

.....

Quantity of sheets attached:



America:

Watson-Marlow Pumps Group
37 Upton Technology Park
Wilmington, MA 01887
USA
Telephone: 800 - 282 - 8823
 978 - 658 - 6168
Fax: 978 - 658 - 0041
E-mail: support@wmftg.us
Internet: www.wmftg.com

Other areas:

Watson-Marlow Bredel B.V.
P.O. Box 47
NL-7490 AA Delden
The Netherlands
Phone: +31 74 3770000
Fax: +31 74 3761175
E-Mail: bredel@wmftg.com
Internet: www.wmftg.com

TS03-060-H

28-29210391