

730 PnN Installation, operating, and maintenance manual

Contents

1 Certification	3
1.1 Declaration of conformity	4
1.2 Declaration of incorporation	5
2 When you unpack your pump	6
2.1 Unpacking your pump	6
2.2 Packaging disposal	6
2.3 Inspection	6
2.4 Components supplied	6
2.5 Storage	6
3 Information for returning pumps	7
4 Peristaltic pumps - an overview	7
5 Warranty	8
6 Safety notes	9
7 Pump specifications	12
7.1 Weights	13
7.2 Pumphead options	13
8 Good pump installation practice	14
8.1 General recommendations	14
8.2 Dos and don'ts	15
9 Pump operation	16
9.1 Keypad layout and key IDs	16
9.2 Starting and stopping	17
9.3 Using up and down keys	17
9.4 Maximum speed	17
9.5 Change rotation direction	17
10 Connecting to a power supply	18
10.1 Conductor colour coding	19
10.2 Wiring the NEMA module - PROFINET® pumps	19
11 Start-up check list	21
12 PROFINET® control wiring	21
12.1 Features on the rear of the pump	22
12.2 RJ45 connections	23
12.3 Control wiring	23

12.4 N Module and F Module	27
12.5 Input/output connectors	30
12.6 PROFINET® pump external interface parameters	32
12.7 Network topology	33
13 Switching the pump on for the first time	35
13.1 Selecting the display language	35
13.2 First-time start-up defaults	37
14 Switching the pump on in subsequent power cycles	39
15 Main menu	40
15.1 Security settings	41
15.2 General settings	51
15.3 Change mode	62
15.4 Control settings	62
15.5 Configure inputs	64
15.6 Help	68
16 Mode menu	69
17 Manual	70
17.1 Start	70
17.2 Stop	71
17.3 Increasing and decreasing flow rate	71
18 Flow calibration	73
18.1 Setting the flow calibration	73
19 PROFINET® mode	76
19.1 Behaviour on start up	76
19.2 Configure PROFINET® settings	76
19.3 PROFINET® mode	80
19.4 Pump parameters	80
19.5 GSDML compatibility guide	85
20 Sensors	86
20.1 Sensor wiring	87
20.2 Setting up the sensors	88
20.3 Start up delay	92
20.4 Generic sensors	94
20.5 Flow sensor reading	105
21 Troubleshooting	106
21.1 Error codes	106
21.2 Technical support	107

22 Drive maintenance	108
23 Drive spares	109
24 Pumphead replacement	110
24.1 720R and 720RE pumphead replacement	110
25 Tube replacement	111
25.1 Continuous tubing	111
25.2 Tube elements	111
26 Ordering information	113
26.1 Pump part numbers	113
26.2 Tubing and element part numbers	114
26.3 Pumphead spares	116
27 Performance data	120
27.1 720R, 720RE, 720R/RX and 720RE/REX performance data	120
28 Trademarks	123
29 Disclaimers	124
30 Publication history	125
31 List of tables and figures	126
31.1 Tables	126
31.2 Figures	127

Original instructions

The original instructions for this manual have been written in English. Other language versions of this manual are a translation of the original instructions

1 Certification

Certification documents follow on the next pages.

1.1 Declaration of conformity



Watson-Marlow Limited
Falmouth
Cornwall
TR11 4RU
England

EC Declaration of Conformity

- 530 Cased pumps (Models: S, SN, U, UN, Du, DuN, Bp, BpN, En, EnN, Pn, PnN)
630 Cased pumps (Models: S, SN, U, UN, Du, DuN, Bp, BpN, En, EnN, Pn, PnN)
730 Cased pumps (Models: SN, UN, DuN, BpN, EnN, PnN)
- Manufacturer:
Watson Marlow Ltd
Bickland Water Road
Falmouth
TR11 4RU
UK
- This declaration of conformity is issued under the sole responsibility of the manufacturer
- All models and versions of the 530, 630 and 730 series of cased peristaltic pump with all approved pump heads, tubing and accessories.
- The object of the declaration described above is in conformity with the relevant Union harmonisation legislation:
Machinery Directive 2006/42/EC
EMC Directive 2014/30/EC
ROHS Directive 2015/863
- Harmonised standards used:
BS EN61010-1:2010 third edition Safety requirements for electrical equipment for measurement, control, and laboratory use Part 1: General requirements
EN61326-1:2013 Electrical equipment for measurement, control and laboratory use – EMC requirements Part 1: General requirements
BS EN 60529:1992+A2:2013 Degrees of protection provided by enclosures (IP code)
- Intertek Testing and Certification Ltd, No: 3272281, performed compliance testing to UL 61010-1:2012 and CSA C22.2#61010-1-12:2012 and issued certification of compliance to these standards.

Signed for and behalf of:
Watson Marlow Ltd
Falmouth, December 2020

Simon Nicholson, Managing Director, Watson-Marlow Limited

1.2 Declaration of incorporation



Watson-Marlow Ltd
Falmouth
Cornwall
TR11 4RU
England

Declaration of Incorporation

In accordance with the Machinery Directive 2006/42/EC that if this unit is to be installed into a machine or is to be assembled with other machines for installations, it shall not be put into service until the relevant machinery has been declared in conformity.

We hereby declare that:

Peristaltic Pump

Series: 530, 630 and 730 cased pumps

the following harmonised standards have been applied and fulfilled for health and safety requirements:

Safety of Machinery – EN ISO 12100

Safety of Machinery – Electrical Equipment of Machines BS EN 60204-1

Quality Management System – ISO 9001

and the technical documentation is compiled in accordance with Annex VII(B) of the Directive.

We undertake to transmit, in response to a reasoned request by the appropriate national authorities, relevant information on the partly completed machinery identified above. The method of transmission shall be by mail or email.

The pump head is incomplete and must not be put into service until the machinery into which it is to be incorporated has been declared in conformity with the provisions of the Directive.

Person authorised to compile the technical documents:

A handwritten signature in black ink, appearing to read 'N. Ashburn'.

Nancy Ashburn, Head of Design & Engineering, Watson-Marlow Ltd

Place and date of declaration: Watson-Marlow Ltd, 20.04.2020

Responsible person:

A handwritten signature in black ink, appearing to read 'S. Nicholson'.

Simon Nicholson, Managing Director, Watson-Marlow Ltd

2 When you unpack your pump

2.1 Unpacking your pump

Unpack all parts carefully, retaining the packaging until you are sure all components are present and in good order. Check against the components supplied list, below.

2.2 Packaging disposal

Dispose of packaging materials safely, and in accordance with regulations in your area. The outer carton is made of corrugated cardboard and can be recycled.

2.3 Inspection

Check that all components are present. Inspect components for damage in transit. If anything is missing or damaged, contact your distributor immediately.

2.4 Components supplied

730 Components

- 730 pump drive unit, fitted with pumphead if specified as a pump
- The designated power cable (attached to the pump drive unit)
- A 730N module providing pump ingress protection to IP66, NEMA 4X
- **Note:** the module is attached for transit, but must be removed to allow wiring up, voltage selection and fuse inspection and then re-affixed before the pump is operated.
- Product safety information booklet incorporating quick start manual

2.5 Storage

This product has an extended shelf life. However, care should be taken after storage to ensure that all parts function correctly. Please observe the storage recommendations and use-by dates which apply to tubing you may wish to bring into service after storage.

3 Information for returning pumps

Before returning products, they must be thoroughly cleaned/decontaminated. The declaration confirming this should be completed and returned to us in advance of the item being shipped.

You are required to complete and return a decontamination declaration stating all fluids that have been in contact with the equipment being returned to us.

On receipt of the declaration, we will issue a Returns Authorisation Number. We reserve the right to quarantine or refuse any equipment that is not displaying a Returns Authorisation Number.

Please complete a separate decontamination declaration for each product and use the correct form that denotes the location you wish to return the equipment to. A copy of the appropriate decontamination declaration can be downloaded from the Watson- Marlow website at www.wmftg.com/decon.

If you have any queries then please contact your local Watson-Marlow representative for further assistance at www.wmftg.com/contact.

4 Peristaltic pumps - an overview

Peristaltic pumps are the simplest possible pump, with no valves, seals or glands to clog or corrode. The fluid contacts only the bore of a tube, eliminating the risk of the pump contaminating the fluid, or the fluid contaminating the pump. Peristaltic pumps can operate dry without risk.

How they work

A compressible tube is squeezed between a roller and a track on an arc of a circle, creating a seal at the point of contact. As the roller advances along the tube, the seal also advances. After the roller has passed, the tube returns to its original shape, creating a partial vacuum which is filled by fluid drawn from the inlet port.

Before the roller reaches the end of the track, a second roller compresses the tube at the start of the track, isolating a packet of fluid between the compression points. As the first roller leaves the track, the second continues to advance, expelling the packet of fluid through the pump's discharge port. At the same time, a new partial vacuum is created behind the second roller into which more fluid is drawn from the inlet port.

Backflow and siphoning do not occur, and the pump effectively seals the tube when it is inactive. No valves are needed.

The principle may be demonstrated by squeezing a soft tube between thumb and finger and sliding it along: fluid is expelled from one end of the tube while more is drawn in at the other.

Animal digestive tracts function in a similar way.

Suitable applications

Peristaltic pumping is ideal for most fluids, including viscous, shear-sensitive, corrosive and abrasive fluids, and those containing suspended solids. They are especially useful for pumping operations where hygiene is important.

Peristaltic pumps operate on the positive displacement principle. They are particularly suitable for metering, dosing and dispensing applications. Pumps are easy to install, simple to operate and inexpensive to maintain.

5 Warranty

Watson-Marlow Limited ("Watson-Marlow") warrants this product to be free from defects in materials and workmanship for five years from the date of shipment, under normal use and service.

Watson-Marlow's sole responsibility and the customer's exclusive remedy for any claim arising out of the purchase of any product from Watson-Marlow is, at Watson-Marlow's option: repair, replacement or credit, where applicable.

Unless otherwise agreed in writing, the foregoing warranty is limited to the country in which the product is sold.

No employee, agent or representative of Watson-Marlow has the authority to bind Watson-Marlow to any warranty other than the foregoing unless in writing and signed by a director of Watson-Marlow. Watson-Marlow makes no warranty of the fitness of its products for a particular purpose.

In no event:

- i. shall the cost of the customer's exclusive remedy exceed the purchase price of the product;
- ii. shall Watson-Marlow be liable for any special, indirect, incidental, consequential, or exemplary damages, however arising, even if Watson-Marlow has been advised of the possibility of such damages.

Watson-Marlow shall not be liable for any loss, damage, or expense directly or indirectly related to or arising out of the use of its products, including damage or injury caused to other products, machinery, buildings, or property. Watson-Marlow shall not be liable for consequential damages, including without limitation, lost profits, loss of time, inconvenience, loss of product pumped, and loss of production.

This warranty does not obligate Watson-Marlow to bear any costs of removal, installation, transportation, or other charges which may arise in connection with a warranty claim.

Watson-Marlow shall not be responsible for shipping damage of returned items.

Conditions

- Products must be returned by pre-arrangement to Watson-Marlow, or a Watson-Marlow approved service centre.
- All repairs or modifications must have been made by Watson-Marlow Limited, or a Watson-Marlow approved service centre or with the express permission in writing of Watson-Marlow, signed by a manager or director of Watson-Marlow.
- Any remote control or system connections must be made in accordance to Watson-Marlow recommendations.
- All PROFINET® systems must be installed or certified by a suitably trained installation engineer.

Exceptions

- Consumable items including tubing and pumping elements are excluded.
- Pumphead rollers are excluded.
- Repairs or service necessitated by normal wear and tear or by lack of reasonable and proper maintenance are excluded.
- Products which, in the judgement of Watson-Marlow, have been abused, misused, or subject to malicious or accidental damage or neglect are excluded.
- Failure caused by electrical surge is excluded.
- Failure caused by incorrect or sub-standard system wiring is excluded.
- Damage by chemical attack is excluded.
- Ancillaries such as leak detectors are excluded.
- Failure caused by UV light or direct sunlight.
- All ReNu pumpheads are excluded
- Any attempt to disassemble a Watson-Marlow product will invalidate the product warranty.

Watson-Marlow reserves the right to amend these terms and conditions at any time.

6 Safety notes

This safety information should be used in conjunction with the rest of this operating manual.

In the interests of safety, this pump and pumphead should only be used by competent, suitably trained personnel after they have read and understood the manual and considered any hazard involved. If the pump is used in a manner not specified by Watson-Marlow Limited, the protection provided by the pump may be impaired. Any person who is involved in the installation or maintenance of this equipment should be fully competent to carry out the work. This person should also be familiar with all relevant health and safety protocols, regulations and guidance.



This symbol, used on the pump and in the manual, means: An appropriate safety instruction should be followed or caution to a potential hazard exists.



This symbol, used on the pump and in the manual, means: Do not allow fingers to contact moving parts.



This symbol, used on the pump and in the manual, means: Caution, hot surface.



This symbol, used on the pump and in the manual, means: Caution, risk of electric shock.



This symbol, used on the pump and in the manual, means: Personal Protective Equipment (PPE) must be worn.



This symbol, used on the pump and in the manual, means: Recycle this product under the terms of the EU Waste Electrical and Electronic Equipment (WEEE) Directive.



Within the 630 and 730 pumps there are thermal fuses which self-reset; if they trip, error code "Err17 Under Voltage" is displayed.



Fundamental work with regard to lifting, transportation, installation, starting-up, maintenance and repair should be performed by qualified personnel only. The unit must be isolated from mains power while work is being carried out. The motor must be secured against accidental start-up.



Some pumps weigh more than 18kg (the exact weight depends on the model and pumphead - see on the pump). Lifting should be performed according to standard Health and Safety guidelines. Finger recesses are built into the sides of the lower shell for convenience in lifting; in addition, the pump can conveniently be lifted by grasping the pumphead and (where fitted) the N Module at the rear of the pump.



There is a user-replaceable fuse located at the rear of the pump. Some country specific mains plugs contain an additional replaceable fuse. Fuses must be replaced with parts with the same rating.



There are no user-serviceable fuses or parts inside this pump.
Note - the mains power supply cable is supplied hardwired into the pump and is not customer replaceable.
Observe voltage selector switch setting for your region



IP66 pumps are supplied with a mains plug. The gland at the NEMA Module end of the cable is IP66 rated. The mains plug at the opposite end of the cable is NOT IP66 rated. It is the user's responsibility to ensure that the connection to the mains supply is IP66 rated.

This pump must be used only for its intended purpose.

The pump must be accessible at all times to facilitate operation and maintenance. Access points must not be obstructed or blocked. Do not fit any devices to the drive unit other than those tested and approved by Watson-Marlow. Doing so could lead to injury to persons or damage to property for which no liability can be accepted.

The pump's main plug is the disconnecting device (for isolating the motor drive from the mains supply in an emergency). Do not position the pump so that it is difficult to disconnect the mains plug.



If hazardous fluids are to be pumped, safety procedures specific to the particular fluid and application must be put in place to protect against injury to persons.



This product does not comply with the ATEX directive and must not be used in explosive atmospheres.



Ensure the chemicals to be pumped are compatible with the pumphead, lubricant (where applicable), tubing, pipework and fittings to be used with the pump. Please refer to the chemical compatibility guide which can be found at: www.wmftg.com/chemical. If you need to use the pump with any other chemical please contact Watson-Marlow to confirm compatibility.



If the Auto Restart feature is enabled it may cause the pump to start as soon as power is turned on.

Auto Restart only affects operation of Manual mode and PROFINET® mode.

If Auto Restart is enabled the "!" Symbol is shown on the screen to warn users that the pump may operate without any manual intervention (pump resumes with previous settings).

Do not use Auto Restart for more than:

- 1 mains power start per 2 hours

We recommend remote control where a high number of starts is required.



If the pump is configured to PROFINET® mode it will respond to remote commands at any time including immediately after power on. The pump may operate without any manual intervention (e.g. a remote setpoint could start the pump with no key press required).



There are moving parts inside the pumphead. Before opening the tool-unlockable guard or tool-unlockable track, ensure that the following safety directions are followed:



1. Ensure the pump is isolated from the mains power.
2. Ensure that there is no pressure in the pipeline.
3. If a tube failure has occurred, ensure that any fluid in the pumphead has been allowed to drain to a suitable vessel, container or drain.
4. Ensure that appropriate Personal Protective Equipment (PPE) is worn.



Primary operator protection from rotating parts of the pump is provided by the pumphead safeguard. Note that safeguards differ, depending on the type of pumphead. See the pumphead section of the manual.

7 Pump specifications

Table 1 - Specification ratings

Operating temperature	5 °C to 40 °C (41 °F to 104 °F)
Storage temperature	730: -25 °C to 65 °C (-13 °F to 149 °F)
Humidity (non-condensing)	80 % up to 31 °C (88 °F) decreasing linearly to 50 % at 40 °C (104 °F)
Maximum altitude	2000 m (6560 ft)
Power Rating	730: 350 VA
Supply voltage	100-120 V/200-240 V 50/60 Hz 1 pH (Subject to regional cord sets and supply)
Maximum voltage fluctuation	+/-10 % of nominal voltage. A well regulated electrical mains supply is required along with cable connections conforming to the best practice of noise immunity.
Full load current	730: <1.5 A @ 230 V; <3.0 A @ 115 V
Fuse rating	T2.5AH250V (5x20 mm)
Installation category (overvoltage category)	II
Pollution degree	2
IP	730: IP66 to BS EN 60529. Meets the requirements of NEMA 4X to NEMA 250 *(indoor use - protect from prolonged UV exposure)
dB rating	
	730: < 85 dB (A) @ 1 m
Control ratio	730: 0.1-360 rpm (3600:1)
Maximum speed	730: 360 rpm

7.1 Weights

Table 2 - Weights

730	Drive only		+ 720R, 720RE		+ 720RX, 720REX	
	kg	lb oz	kg	lb oz	kg	lb oz
IP66 (NEMA 4X)	18.5	40 13	25	55 2	31.5	69 7



Some pumps weigh more than 18 kg (the exact weight depends on the model and pumphead - see on the pump). Lifting should be performed according to standard Health and Safety guidelines. Finger recesses are built into the sides of the lower shell for convenience in lifting; in addition, the pump can conveniently be lifted by grasping the pumphead and (where fitted) the module at the rear of the pump.

7.2 Pumphead options

Figure 1 - 730 pump range

720R, 720R/RX, 720RE, 720RE/REX:



8 Good pump installation practice

8.1 General recommendations

It is recommended that the pump is sited on a flat, horizontal, rigid surface, free from excessive vibration, to ensure the correct lubrication of the gearbox and correct pumphead operation. Allow a free flow of air around the pump to ensure that heat can be dissipated. Ensure that the ambient temperature around the pump does not exceed the recommended maximum operating temperature. The STOP key on pumps supplied with a keypad will always stop the pump. However, it is recommended that a suitable local emergency stop device is fitted into the mains supply to the pump. Do not stack the pumps more than the recommended maximum number. When the pumps are stacked, ensure that the ambient temperature around all the pumps in the stack does not exceed the recommended maximum operating temperature.



Figure 2 - Pump stacking

The pump may be set up so that the direction of rotor rotation is clockwise or counter-clockwise, whichever is required.

Please note, however, that for some pumpheads the tube life will be greater if the rotor rotates clockwise; and that performance against pressure will be maximised if the rotor rotates counter-clockwise. To achieve pressure in some pumpheads the pump must rotate counter-clockwise.



Figure 3 - Rotor direction

Peristaltic pumps are self-priming and self-sealing against backflow. No valves are required in inlet or discharge line, except those specified as below.



Users must fit a non-return valve between the pump and the discharge pipework to avoid the sudden release of pressurised fluid in the event of a pumphead or tube failure. This shall be fitted immediately after the discharge of the pump.

Valves in the process flow must be opened before the pump operates. Users are advised to fit a pressure relief device between the pump and any valve on the discharge side of the pump to protect against damage caused by accidental operation with the discharge valve closed.

8.2 Dos and don'ts

- Do not build a pump into a tight location without adequate airflow around the pump.
- Do keep delivery and suction tubes as short and direct as possible - though ideally not shorter than one metre - and follow the straightest route. Use bends of large radius: at least four times the tubing diameter. Ensure that connecting pipework and fittings are suitably rated to handle the predicted pipeline pressure. Avoid pipe reducers and lengths of smaller bore tubing than the pumphead section, particularly in pipelines on the suction side. Any valves in the pipeline must not restrict the flow. Any valves in the flow line must be open when the pump is running.
- Do ensure that on longer tube runs at least one metre of smooth bore, flexible tubing is connected to the inlet and discharge port of the pumphead to help to minimise impulse losses and pulsation in the pipeline. This is especially important with viscous fluids and when connecting to rigid pipework.
- Do use suction and delivery pipes equal to or larger than the tubing diameter bore. When pumping viscous fluids use pipe runs with a bore several times larger than the pump tube.
- Do site the pump at or just below the level of the fluid to be pumped if possible. This will ensure flooded suction and maximum pumping efficiency.
- Do run at slow speed when pumping viscous fluids. Flooded suction will enhance pumping performance, particularly for materials of a viscous nature.
- Do recalibrate after changing tubing, fluid or any connecting pipework. It is also recommended that the pump is recalibrated periodically to maintain accuracy.
- Do not pump any chemical not compatible with the tube or pumphead.
- Do not run the pump with no tube or element fitted to the pumphead.
- Do not strap the control and mains cables together.
- Do ensure if your product has an N module, that the module is fitted with the seals intact and properly located. Ensure that the holes for the cable glands are properly sealed to maintain the IP/NEMA rating.

Tube selection: The chemical compatibility guide published on the Watson Marlow website is for guidance. If in any doubt about the compatibility of a tube material and the duty fluid, request a Watson-Marlow tube sample card for immersion trials.

When using Marprene or Bioprene continuous tubing, do re-tension the tube after the first 30 minutes of running.

9 Pump operation

9.1 Keypad layout and key IDs



Figure 4 - Keypad layout and key IDs

HOME key

When the **HOME** key is pressed it will return the user to the last known operating mode. If modifying pump settings when the **HOME** key is pressed, it will disregard any setting changes and return you to the last known operating mode.

FUNCTION keys

FUNCTION keys, when pressed, will perform the function displayed on the screen directly above the relevant function key.

^ and v keys

These keys are used to change the programmable values within the pump. These keys are also used to move the selection bar up and down in the menus.

MODE key

To change modes or mode settings, press the **MODE** key. The **MODE** key can be pressed at any time to enter the mode menu. If modifying pump settings when the **MODE** key is pressed, it will disregard any setting changes and return you to the **MODE** menu.

9.2 Starting and stopping

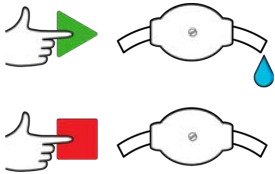

Figure 5 - Starting and stopping

9.3 Using up and down keys

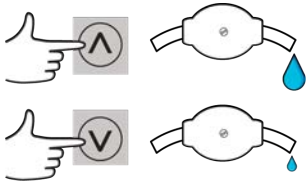

Figure 6 - Using up and down keys

9.4 Maximum speed

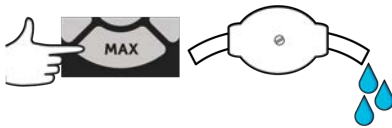

Figure 7 - Maximum speed

9.5 Change rotation direction

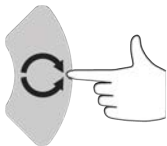

Figure 8 - Change rotation direction

10 Connecting to a power supply

A well regulated electrical mains supply is required along with cable connections conforming to the best practice of noise immunity. It is not recommended to site these drives alongside electrical devices that may generate mains-borne noise, for example 3-phase contactors and inductive heaters.



Set the voltage selector to 115 V for 100-120 V 50/60 Hz supplies or 230 V for 200-240 V 50/60 Hz supplies. Always check the voltage selector switch before connecting to the mains supply or the pump will be damaged.

~100-120V



~200-240V



Make suitable connection to an earthed single-phase mains electricity supply.



If the pump type is one with an N Module, the voltage selector is not visible while the module is in place. It is mounted in the switch plate at the rear of the pump, protected from water by the N Module. The module must be removed to allow access to the switch plate. Do not switch the pump on unless you have checked that it is set to suit your power supply by removing the module and inspecting the switch and then refitting the module.

1.



3.



2.



4.



Figure 9 - Voltage selector



We recommend using a commercially available supply voltage surge and/or noise suppression where there is excessive electrical noise.



Ensure that all power supply cables are adequately rated for the equipment. Only use with supplied power cable.



The pump must be positioned so that the disconnection device is easily accessible when the equipment is in use. The pump's power input plug is the disconnecting device (for isolating the motor drive from the power supply in an emergency).



IP66 pumps are supplied with a mains plug. The gland at the NEMA Module end of the cable is IP66 rated. The mains plug at the opposite end of the cable is NOT IP66 rated. It is your responsibility to ensure that the connection to the mains supply is IP66 rated.

10.1 Conductor colour coding

Table 3 - Conductor colour coding

Conductor type	European colour	North American colour
Line	Brown	Black
Neutral	Blue	White
Ground	Green/Yellow	Green

10.2 Wiring the NEMA module - PROFINET® pumps

The NEMA 4X modules fitted to 530, 630 and 730 PnN cased pumps have two pairs of wiring ports. Two M16 ports are provided, together with glands to seal circular cross-section cables ranging in diameter from 4 mm to 10 mm (5/32 in to 13/32 in.) PROFINET connection is via the two M12 connectors mounted to the rear of the NEMA module.

Figure 10 - Earth screening of control cables onPROFINET® NEMA module



Control cable earth screening connected to Earth terminal (J6) on adapter PCB when plastic cable gland is used.

Figure 10 - Earth screening of control cables onPROFINET® NEMA module

②



No additional control cable earth screening required when EMC gland is used.



NEMA module with conductive mounting kit (for connecting screen to earth for PROFINET®).

11 Start-up check list

Note: See also "Tube replacement " on page 111.

- Ensure that proper connections are achieved between the pump and suction and discharge piping.
- Ensure proper connection has been made to a suitable power supply.
- Ensure that the recommendations in the section "Good pump installation practice" on page 14 are followed.

12 PROFINET® control wiring



Never apply mains power to the D-connectors. Apply the correct signals to the pins shown. Limit signals to the maximum values shown. Do not apply voltage across other pins. Permanent damage, not covered by warranty, may result.



Keep 4-20 mA and low voltage signals separate from mains power. Use separate glanded input cables. Following best EMC practice and use of shielded glands is recommended.

12.1 Features on the rear of the pump

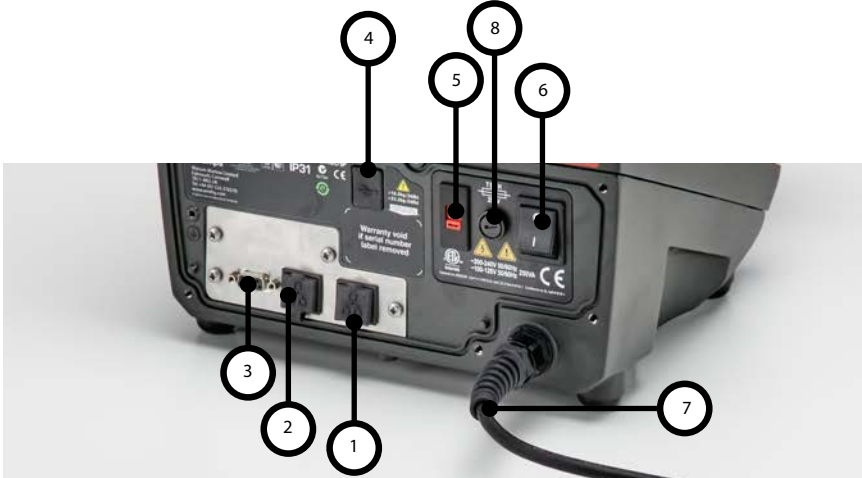

1	RJ45 connection 1
2	RJ45 connection 2
3	Standard - 9 way D - Sensor connector (Female)
4	USB (Type A) port for service use only
5	Voltage selector switch
6	On/Off switch
7	Mains power cable
8	Customer replaceable fuse

12.2 RJ45 connections

Connect an RJ45 (CAT5 or above, shielded recommended) network cable from the PC to the pump connection port 1 or 2.

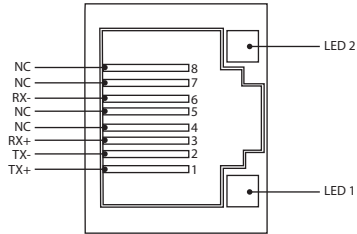

Figure 11 - RJ45 connections

LED 1	LED 2	Indication
Low	Low	Off
Low	High	Yellow LED on for link detected, flickers to indicate 10 Mbit activity
High	Low	One green LED on for link detected, flickers to indicate 100 Mbit activity

12.3 Control wiring

Standard - 9 way D - Sensor connector (Female/Chassis Skt)

Recommended control cable: 7/0.2 mm 24AWG screened, circular. The cable screen should be earthed with a 360 deg connection to a conductive back-shell.

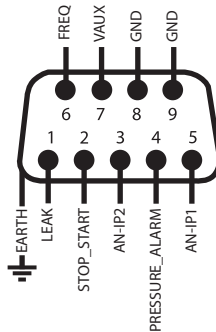

Figure 12 - Wiring the 9 way D sensor connector

Key to symbols











	Run		Input		Keypad direction change
	Stop		Output		Dry (no leak)
	Clockwise rotation		Manual (keypad) control		Wet (leak detected)
	Anticlockwise rotation		Analogue		

Table 4 - Wiring the D-Connector



Signal Name	Input or output	Configurable	Signal response
 <p>ANALOGUE #1</p>	Input	Yes	
 <p>ANALOGUE #2</p>	Input	Yes	

Table 4 - Wiring the D-Connector





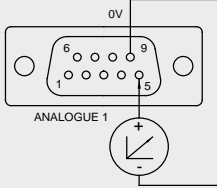
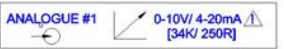
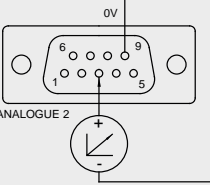

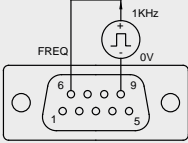

Signal Name	Input or output	Configurable	Signal response
	Input	Yes	
			
	Input	Yes	
			

Table 4 - Wiring the D-Connector

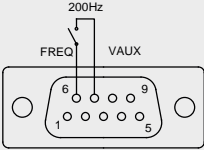
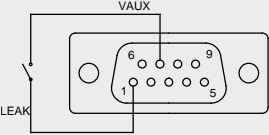
Signal Name	Input or output	Configurable	Signal response
	Input	Yes	
	Input	Yes	

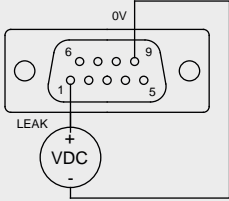
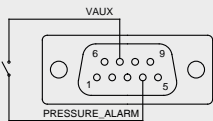
12.4 N Module and F Module

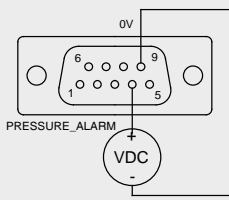

Never apply mains power to the M12 connectors. Apply the correct signals to the terminals. Limit signals to the maximum values shown. Do not apply voltage across other terminals. Permanent damage, not covered by warranty, may result.



The recommended cable and cable glands must be used for the IP66 (NEMA 4X) version of the pump; otherwise ingress protection may be impaired.



Ensure that the module cover is correctly secured at all times by all screws supplied. Failure to do so may compromise the IP66 (NEMA 4X) protection.



Ensure that unused openings on the module are sealed using the blanking plugs provided. Failure to do so may compromise the IP66 (NEMA 4X) protection.

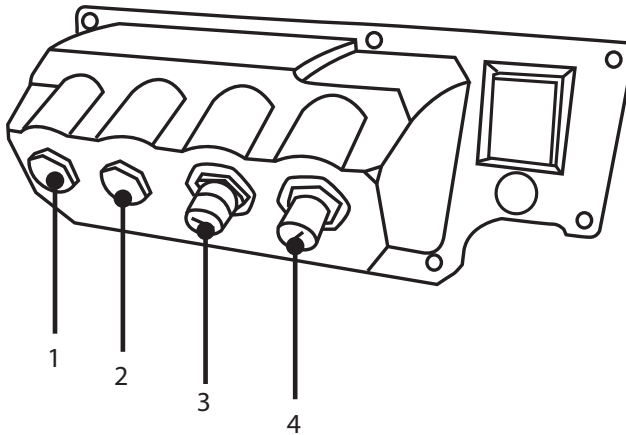

Figure 13 - N Module and F Module

1. M16 port

2. M16 port

3. M12 Connector - PROFINET connection

4. M12 Connector - PROFINET connection

PROFINET (Industrial Ethernet) connection

There are two communication connectors on the rear of the N Module for PROFINET (Industrial Ethernet) connection (3,4). Both connectors have the same pin configuration. The pin configuration and the signal response is shown below.

Plugs and cables for these connectors should be: M12, male, 4-Pin D coded, shielded.

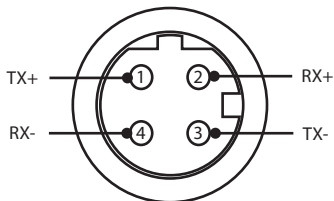
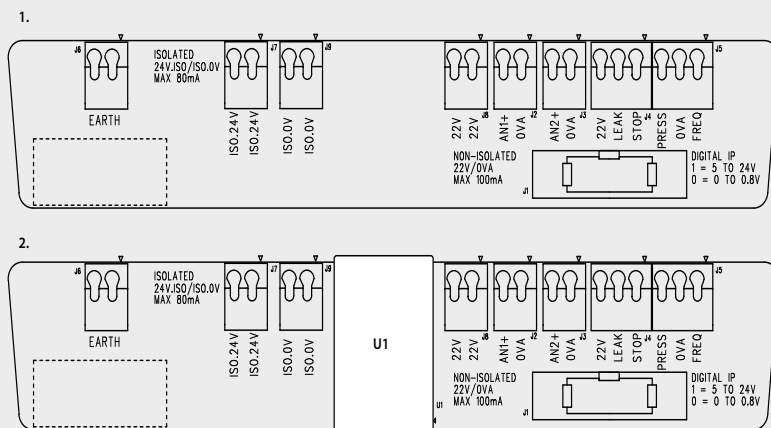

Figure 14 - Ethernet connection

Adapter PCB

Figure 15 - Adapter PCB



1. Without isolated power supply option (N Module)

2. With isolated power supply option (F Module)

Note: Disconnect the adapter module by use of the ribbon eject levers. It is recommended to leave the 9W connector permanently attached to the pump.

Recommended control cable: metric = 0.05 sq mm - 1.31 sq mm solid and stranded. USA = 30AWG - 16AWG solid stranded. Cable: circular. Max/min outside diameter to ensure a seal when passed through the standard gland: 9.5 mm-5 mm. **The cable section must be circular to ensure a seal.**

Power supply options

The NEMA adapter board is available with an isolated power supply option (F-Module). This has a 24 V isolated power supply (maximum output load 80 mA), U1, fitted. As shown below, U1 completely separates the terminal 24 V and 0 V from the pump internal supplies.

The F-Module option may be used if the sensor requires an isolated supply or has a 4-20 mA output which cannot be used with the ground connected load resistor within the pump.

Figure 16 - Power supply options

1.

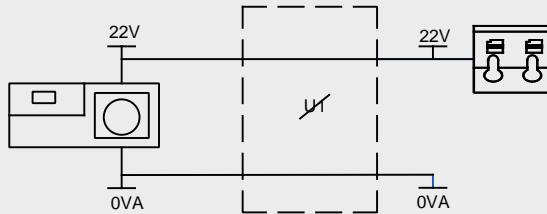

2.

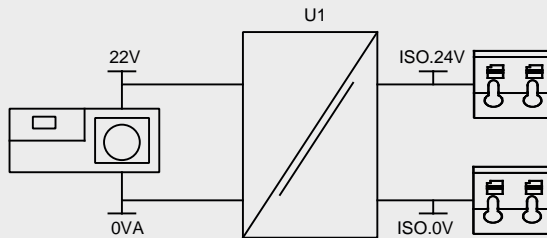

1. Without isolated power supply option (N Module)

2. With isolated power supply option (F Module)

12.5 Input/output connectors

Key to symbols











	Run		Input		Keypad direction change
	Stop		Output		Dry (no leak)
	Clockwise rotation		Manual (keypad) control		Wet (leak detected)
	Anticlockwise rotation		Analogue		

Table 5 - Input/output Connectors











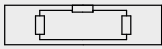
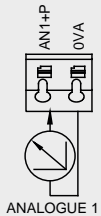
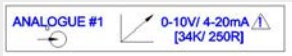
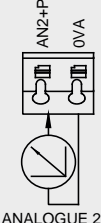

Connector No.	Function	Input or output	Configurable	Signal response
J1			No	Connection to pump
J2		Input	Yes	
J3		Input	Yes	

Table 5 - Input/output Connectors

Connector No.	Function	Input or output	Configurable	Signal response
J4		Input	Yes	<div style="border: 1px solid black; padding: 5px; margin-bottom: 5px;"> <p>START STOP  0  1 [5-24V] </p> </div> <div style="border: 1px solid black; padding: 5px;"> <p>LEAK  0  1 [5-24V] </p> </div>
J5		Input	Yes	<div style="border: 1px solid black; padding: 5px; margin-bottom: 5px;"> <p>PRESSURE  0  1 [5-24V] </p> </div> <div style="border: 1px solid black; padding: 5px;"> <p>FREQ  5V-24V 1mA</p> </div>
J6	<p>1.Earth 2.Earth</p>		No	

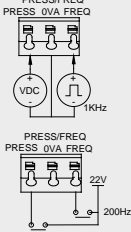
12.6 PROFINET® pump external interface parameters

Table 6 - External interface parameters

Parameter	Limits			Units	Comment	
	Sym	Min	Nom			Max
Digital input voltage high	VD _{IH}	5		24	V	Leak, Stop, PRESSURE_ALARM, Frequency
Digital input voltage low	VD _{IL}	0		0.8	V	Leak, Stop, PRESSURE_ALARM, Frequency
Digital input voltage absolute maximum	VD _{in}	-30		30	V	Non operational
Digital input resistance	RD _{in}	10		110	kΩ	110K for ≤ 5 V
Frequency range	F _{max}	1		1000	Hz	Frequency
Repetition rate	F _{max}	1		10	Hz	Leak, Stop, Pressure
Analogue input, voltage mode	VA _{in}	-15	10	30	V	0-10 V range (100R source impedance)
Analogue input, voltage mode	RVA _{in}		34.4		kΩ	±3 %
Analogue input measurement range	I _{in}	0		25	mA	
Analogue input current absolute maximum	IA _{in}	-50		28	mA	Dissipation limit
Analogue input voltage absolute maximum	VA _{in}	0		7.0	V	Dissipation limit
Analogue input resistance	RI _{IN}		250	270	Ω	250R Sense Res.
Analogue input filter bandwidth	BW		67		Hz	-6 dB Bandwidth
22 V supply output	V _{aux}		18	30	V	Un-regulated
24 V isolated supply output	V24		24			
22 V/24 V supply load current				80	mA	Self-resetting fuse

12.7 Network topology

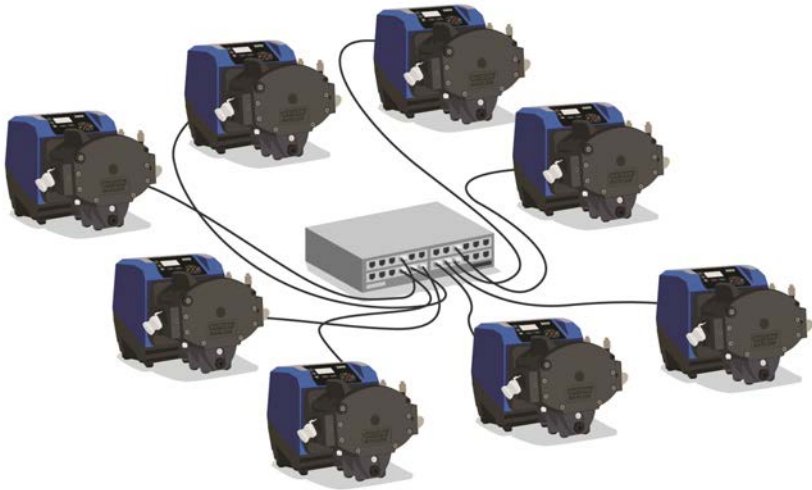

Figure 17 - Star network

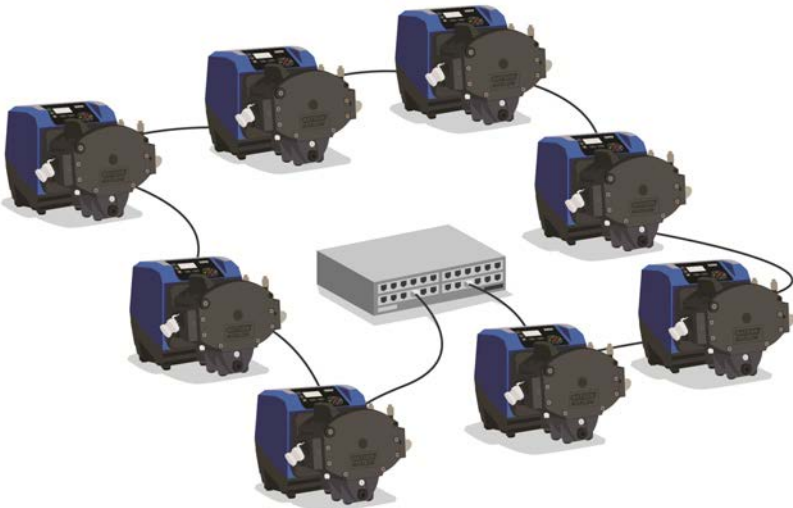

Figure 18 - Ring network

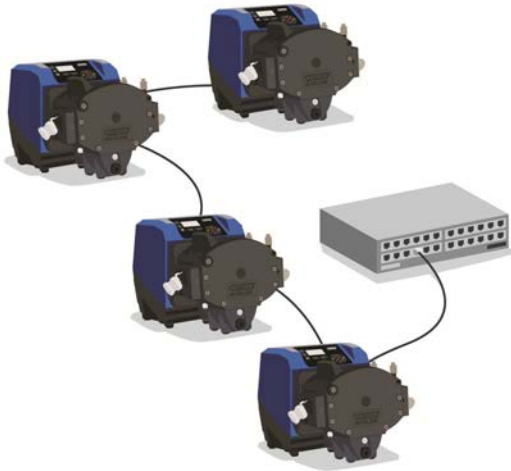

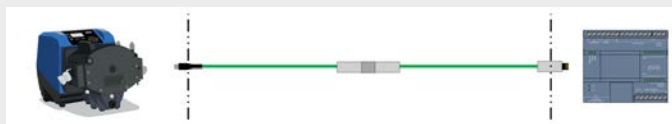

Figure 19 - Line topology

Table 7 - Allowance for one additional connection pair

Cable type—100m maximum length	With NEMA module	Without NEMA module
<p>Cable with two connectors</p> 	✓	✓
<p>Cable with one additional connector pair</p> 	✓	✓
<p>Cable with two additional connector pairs</p> 	✗	✓

13 Switching the pump on for the first time

1. Power up the pump. The pump displays the start-up screen with the Watson-Marlow Pumps logo for three seconds.



13.1 Selecting the display language

1. Use the \wedge / \vee keys to select your chosen language, and press **SELECT**.



2. Your selected language will now be displayed on screen. Choose **CONFIRM** to continue. All text will now appear in your chosen language.



3. Choose **REJECT** to return to the language choice screen. This then proceeds to the home screen.

13.2 First-time start-up defaults



If the Auto Restart feature is enabled it may cause the pump to start as soon as power is turned on.

Auto Restart only affects operation of Manual mode and PROFINET® mode.

If Auto Restart is enabled the "!" Symbol is shown on the screen to warn users that the pump may operate without any manual intervention (pump resumes with previous settings).

Do not use Auto Restart for more than:

- 1 mains power start per 2 hours

We recommend remote control where a high number of starts is required.



If the pump is configured to PROFINET® mode it will respond to remote commands at any time including immediately after power on. The pump may operate without any manual intervention (e.g. a remote setpoint could start the pump with no key press required).

The pump is preset with operational parameters as shown in table below.

Table 8 - First-time start-up defaults

Parameter	730 default
Language	Not set
Default mode	Manual
Default manual speed	360 rpm
Pump status	Stopped
Max speed	360 rpm
Direction	CW
Pumphead	720R
Tube size	25.4 mm
Tube material	Bioprene
Flow calibration	0.92 l/rev
Flow units	rpm
Pump label	WATSON-MARLOW
Asset number	NONE
SG value	1
Keypad lock	Disabled
PIN protection	Not set
Keypad beep	ON

Table 8 - First-time start-up defaults

Parameter	730 default
PIN entry on start-up	ON
Remote start/stop input	High = stop
Leak detector input	High = leak
PROFINET Fail safe	Disabled
PROFINET Fail safe speed	0 rpm
Dose adjust	-
Resume interrupted	-

The pump is now ready to operate according to the defaults listed above.

Note: The display background colour changes according to running state as follows:

- White background indicates pump stopped
- Grey background indicates pump running
- Red background indicates error or alarm

All operating parameters may be changed by means of key-presses (see section "Pump operation" on page 16).

14 Switching the pump on in subsequent power cycles



If the Auto Restart feature is enabled it may cause the pump to start as soon as power is turned on.

Auto Restart only affects operation of Manual mode and PROFINET® mode.

If Auto Restart is enabled the "!" Symbol is shown on the screen to warn users that the pump may operate without any manual intervention (pump resumes with previous settings).

Do not use Auto Restart for more than:

- 1 mains power start per 2 hours

We recommend remote control where a high number of starts is required.



If the pump is configured to PROFINET® mode it will respond to remote commands at any time including immediately after power on. The pump may operate without any manual intervention (e.g. a remote setpoint could start the pump with no key press required).

Subsequent power-up sequences will jump from the start-up screen to the home screen.

- The pump runs a power-on test to confirm proper functioning of the memory and hardware. If a fault is found, an error code is displayed.
- The pump displays the start-up screen with the Watson-Marlow Pumps logo for three seconds followed by the home screen
- Start-up defaults are those in place when the pump was switched off last

Check that the pump is set to operate as you require it. The pump is now ready to operate.

All operating parameters may be changed by means of key-presses (see "Pump operation" on page 16).

Power interruption

This pump has an **Auto Restart** feature (which only affects **Manual** mode) which, when active, will restore the pump to the operating state it was in when power was lost.

Stop/start power cycles

Do not power up/power down the pump more than 12 times in 24 hours, whether manually or by means of the **Auto Restart** facility (which only affects **Manual** mode). We recommend remote control where a high frequency of power cycles is required.

15 Main menu

1. To access the **MAIN MENU** press the **MENU** button from one of the **HOME** screens or **INFO** screens.

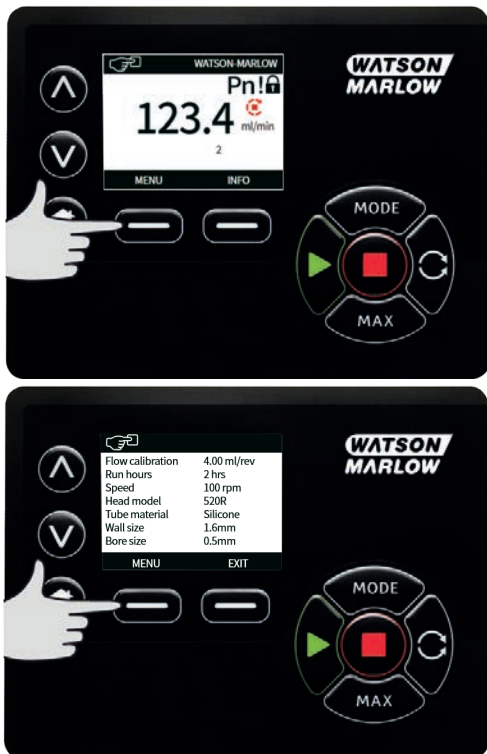

2. This will display the **MAIN MENU** as shown below. Use the \wedge \vee keys to move the selection bar between the available options.
3. Press **SELECT** to choose an option.

4. Press **EXIT** to return to the screen from where the MENU was called.



15.1 Security settings

Security settings can be changed by selecting **SECURITY SETTINGS** from the Main menu.

Auto keypad lock

1. Press **ENABLE/DISABLE** to switch on/off the Auto keypad lock. When active the keypad will lock after 20 seconds of inactivity.



2. Once locked it will display the screen below when any key is pressed. To unlock the keypad press the two **UNLOCK** keys together.



3. The padlock icon will appear on the operating mode home screen to show that keypad lock is activated.
4. Note that the **STOP** key will always work whether the keypad is locked or not.

PIN protection

Using the \wedge / \vee keys select **PIN protection** from the **SECURITY SETTINGS** menu and press **ENABLE/DISABLE** to switch on/off the PIN protection. If PIN protection has been enabled, a Master level PIN will be required to disable PIN lock.

Setting Master PIN

PIN will enable after one minute from the last time the PIN was entered.

Setting the Master PIN protects all functionality. The Master is able to selectively enable functionality for two additional operators. These are defined as User 1 and User 2. They will be able to access this functionality by entering a PIN code assigned to them by the Master user.

1. To set the Master PIN, scroll to **Master level** and press **ENABLE**.

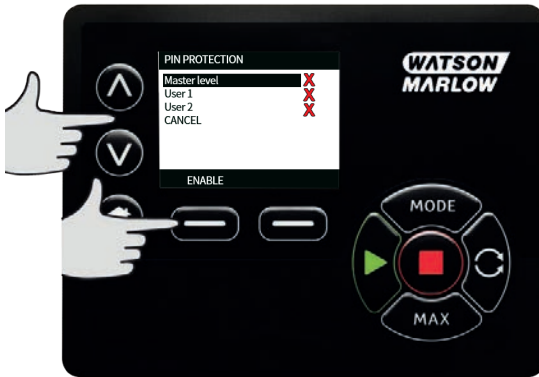

2. To define a four digit Master PIN, use the \wedge / \vee keys to select each digit from 0-9. Once you have the required digit press the **NEXT DIGIT** key. After selecting the fourth digit press **ENTER**.

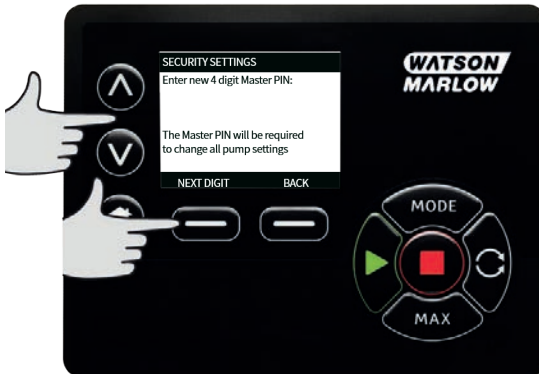

3. Now press **CONFIRM** to check that the number entered is the PIN you require. Press **CHANGE** to return to PIN entry.



4. The following screen will be displayed to indicate that the Master PIN has been applied to access all functionality. Press **NEXT** to selectively enable functionality access for User 1 and User 2.



Configure User 1 security settings

1. The **PIN PROTECTION** level screen will be displayed with **User 1** highlighted, press **ENABLE** to configure User 1 security settings or scroll to configure an alternative User.

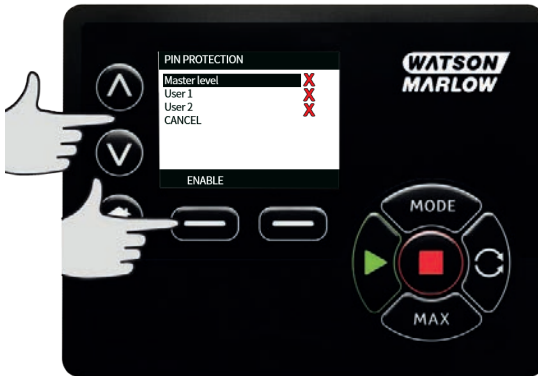

2. **ENABLE** user 1 security settings displays the PIN entry screen for User 1. To define a four digit User 1 PIN, use the \wedge / \vee keys to select each digit from 0-9. Once you have the required digit press the **NEXT DIGIT** key. After selecting the fourth digit press **ENTER**.



3. Now press **CONFIRM** to verify that the number entered is the PIN you require. Press **CHANGE** to return to PIN entry.



4. To define the allowed functionality, use the \wedge / \vee keys to select the functionality and press **ENABLE**. User 1 PIN will allow access to only the enabled functionality, to disable functionality, highlight the enabled functionality and press **DISABLE**. When all the required functionality has been enabled, press **FINISH**.



Configure User 2 security settings

1. The **PIN PROTECTION LEVEL** screen will be displayed with **User 2** highlighted, press **ENABLE** to configure User 2 security settings or scroll to configure an alternative User.

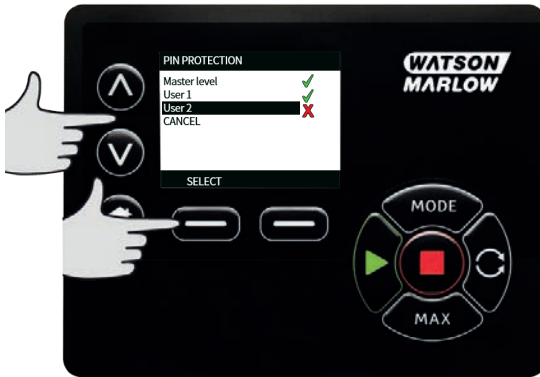

2. **ENABLE** user 2 security settings displays the PIN entry screen for User 2. To define a four digit User 2 PIN, use the \wedge / \vee keys to select each digit from 0-9. Once you have the required digit press the **NEXT DIGIT** key. After selecting the fourth digit press **ENTER**.



- To define the allowed functionality, use the \wedge / \vee keys to select the functionality and press **ENABLE**. User 2 PIN will allow access to only the enabled functionality, to disable functionality, highlight the enabled functionality and press **DISABLE**. When all the required functionality has been enabled, press **FINISH**.



Note: Once Security Settings for User 1 and User 2 have been set by the Master, only the Master PIN will allow access to Security Settings.

- The **HOME** screen will be displayed. A PIN is now required to access all functionality. The Master PIN accesses all pump functionality and the User 1 and User 2 PINs access only the defined functionality. To enter the PIN, use the \wedge / \vee keys to select each digit from 0-9. Once you have the required digit press the **NEXT DIGIT** key. After selecting the fourth digit press **ENTER**.



5. If an incorrect PIN has been entered the following screen will be displayed. NOTE: this screen will also display if the PIN entered does not allow access to that functionality.



6. If a PIN number is entered that is already in use, the following screen will be displayed, press **CHANGE** to input an alternative PIN or **EXIT** to abort



7. If the PIN entered does not allow access to the functionality the following screen will be displayed.



Keypad beep

1. From **SECURITY SETTINGS** scroll to **Keypad beep** using the \wedge / \vee keys and select **ENABLE**. The pump will now beep at every key press.



PIN entry on start-up

The setting **PIN entry during start-up** can be used to configure the software to choose if PIN entry is required during start up.

This feature also means that **Auto Restart** capability is now independent of PIN code entry after start up.

If this setting is enabled ✓ then the pump will require the PIN code to be entered before the pump will enter the home control screen after a power cycle.

If this setting is disabled ✗ then the pump will not require the PIN code to be entered before the pump will enter the home control screen after a power cycle.

The **Auto Restart** response of the pump after a power cycle is now independent of PIN entry.

The default setting, is enabled ✓ so a PIN code will be required after a power cycle before the pump will enter the home control screen.

Disabling this feature does not change any other aspects of PIN code operation. Anyone wishing to modify pump settings will still need to enter the PIN code.

15.2 General settings

To view the general settings menu, select **GENERAL SETTINGS** from the main menu.

Auto restart

This pump includes a feature called **Auto Restart**.

When **Auto Restart** is enabled it will cause the pump to remember it's current operating settings when power is lost and to resume using these as soon as power comes back on.

The ! symbol is also displayed when the **Auto Restart** feature is enabled to warn users that the pump has been configured in a way that could result in unexpected operation.

1. Press **ENABLE/DISABLE** to turn the **Auto Restart** feature on/off (**Manual** mode).

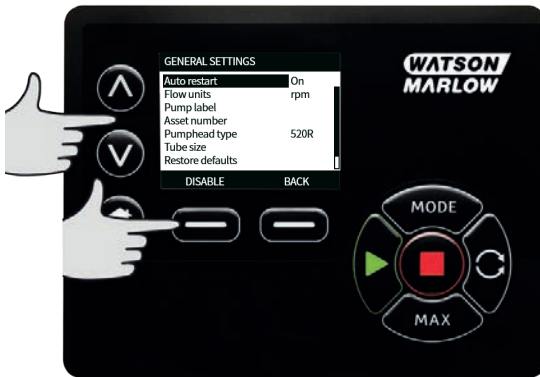

Do not use Auto Restart for more than 12 times in 24 hours. We recommend remote control where a high number of starts is required.

If the Auto Restart feature is enabled it may cause the pump to start as soon as power is turned on.

Auto Restart only affects operation of Manual mode and PROFINET® mode.



If Auto Restart is enabled the "!" Symbol is shown on the screen to warn users that the pump may operate without any manual intervention (pump resumes with previous settings).

Do not use Auto Restart for more than:

- 1 mains power start per 2 hours

We recommend remote control where a high number of starts is required.



If the pump is configured to PROFINET® mode it will respond to remote commands at any time including immediately after power on. The pump may operate without any manual intervention (e.g. a remote setpoint could start the pump with no key press required).

Flow units

The current chosen flow unit is displayed on the right hand side of the screen. To change flow units move the selection bar over the flow unit menu entry and press **SELECT**.

1. Use the \wedge / \vee keys to move the selection bar over the required flow unit, then press **SELECT**. All flow rates displayed on screens will now be in the chosen units.



2. If a mass flow unit is selected, the specific gravity of the fluid must be entered. The following screen is displayed.



3. Use the \wedge / \vee keys to enter the value of the specific gravity, and press **SELECT**.

Pump label

The pump label is a user defined 20 digit alphanumeric label which is displayed in the header bar of the home screen. To define or edit the pump label, move the selection bar over the Pump label menu entry and press **SELECT**. If a pump label has been previously defined, this will be displayed on screen to allow editing, otherwise it will display the default label "WATSON-MARLOW".

1. Use the \wedge / \vee keys to scroll through the available characters for each digit. The available characters are 0-9, A-Z and SPACE.



2. Press **NEXT** to move onto the next character, or **PREVIOUS** to move back to the previous character.

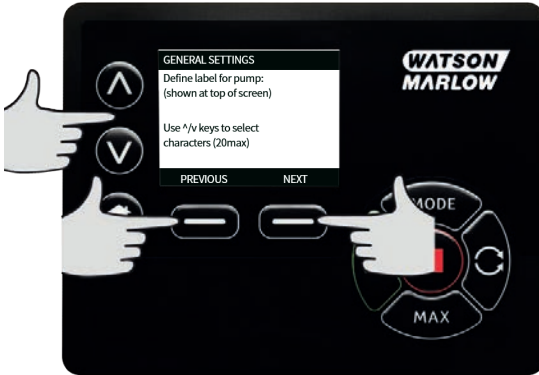

3. Press **FINISH** to save the entry and return to the general settings menu.



Asset number

The Asset number is for users to set a unique asset identification code for the pump. This can help to track pumps on the network and distinguish between different pumps on the network. There is no default factory setting for this parameter and new pumps are supplied without an asset number.

Setting up the asset number.

1. From the main menu, using the \wedge / \vee keys, scroll to **General settings** and press **SELECT**.



2. Using the \wedge / \vee keys, scroll to **Asset number** and press **SELECT**.



3. Using the \wedge / \vee keys, enter a character.



4. There are 20 character slots. Press **NEXT** to confirm your character and to move onto the next. Press **PREVIOUS** to return to the last character slot.



5. Once you have filled the character slots press **FINISH**. This will return you to the **GENERAL SETTINGS** screen.



6. Power the pump off and on again to apply the asset number.

Failsafe speed

A failsafe speed is a dedicated speed the pump uses if an error occurs. Use this to prevent the pump stopping in the event of an error.

Example: disconnect the RJ45 cable from the pump while running on PROFINET® mode and the pump will error.

- If failsafe speed is enabled, the pump will run at the failsafe speed and the network error message will display.
- If failsafe speed is not enabled, the pump will stop running and the network error message will display.

Once the error is acknowledged, the pump will run as normal.

Pumphead type

1. Select **GENERAL SETTINGS** from the main menu.



2. Use the \wedge / \vee keys to move the selection bar over **Pumphead type** and press **SELECT**. The following screen will be displayed.



3. Use the \wedge / \vee keys to move the selection bar over **Pumphead** and press **SELECT**.



- Use the \wedge / \vee keys to move the selection bar over the required pumphead type and press **SELECT**.



Tube size and tube material

- Select **Tube size** from **GENERAL SETTINGS**, then use the \wedge / \vee keys to move the selection bar over **Bore size** and press **SELECT**.

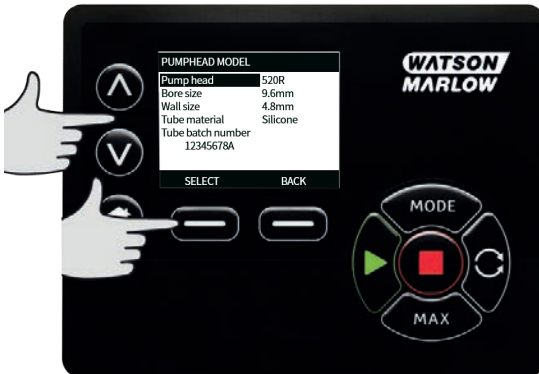

2. Use the \wedge / \vee keys to move the selection bar over the tube size to be used and press **SELECT**.

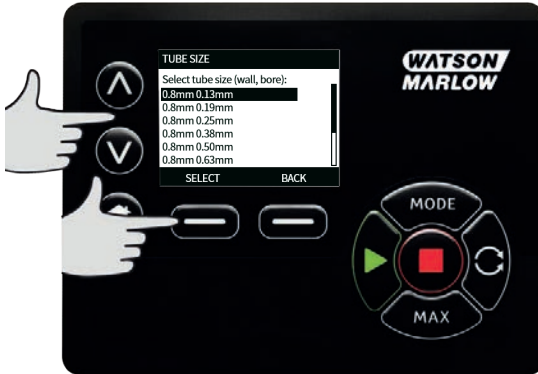

3. If a LoadSure element has been selected then the tube size is displayed as pressure and bore.

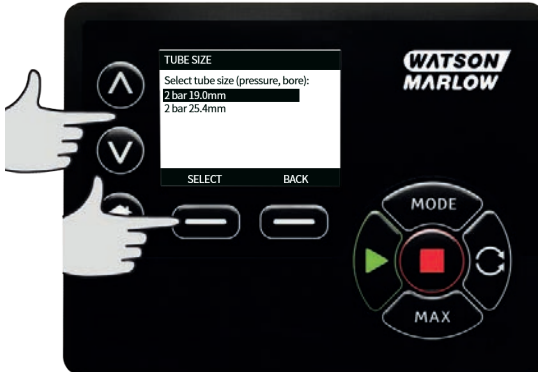

4. This screen also allows you to select the tube material used. Use the \wedge / \vee keys to move the selection bar over **Tube material** and press **SELECT**.



- Use the \wedge / \vee keys to move the selection bar over the tube material to be used and press **SELECT**.



- The **PUMPHEAD MODEL** screen allows the tube Lot Number to be recorded for future reference. Using the \wedge / \vee keys, scroll to **Tube lot number** and press **SELECT**.
- Use the \wedge / \vee keys to scroll through the available characters for each digit. The available characters are 0-9, A-Z, and SPACE.
- Press **NEXT** to move onto the next character, or **PREVIOUS** to move back to the last character.

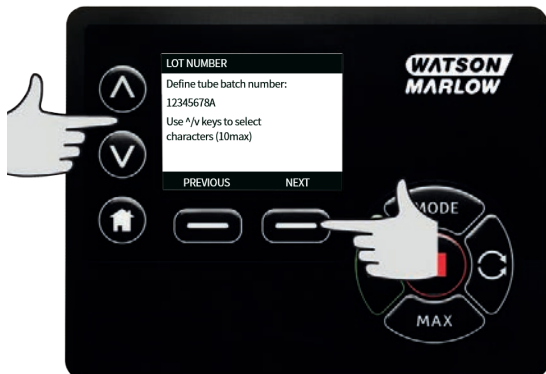

- Press **FINISH** to save the entry and return to the general settings menu.

Restore defaults

- To restore the factory default settings select **Restore defaults** from the **GENERAL SETTINGS** menu.
- There are two confirmation screens to ensure that this function is not carried out in error.

3. Press **CONFIRM** followed by **RE-CONFIRM** to restore the defaults.



Language

1. Select language from the **GENERAL SETTINGS** menu to choose an alternative display language for the pump. The pump must be stopped before changing the language.
2. Using the \wedge/\vee keys, scroll to your required language. Press **SELECT** to confirm.



3. Your selected language will now be displayed on screen. Press **CONFIRM** to continue, all displayed text will now appear in your chosen language.
4. Press **REJECT** to return to the language choice screen.



15.3 Change mode

Selecting **CHANGE MODE** menu from the main menu will navigate you to access the sub-menu shown below. This is the same as pressing the **MODE** key. Please see "Mode menu " on page 69 for further details.

15.4 Control settings

1. Select **CONTROL SETTINGS** from the **MAIN MENU** to access the sub menu shown below. Use the \wedge / \vee keys to move the selection bar. Press **SELECT** to choose the required function.



Speed limit

The maximum speed the pump is capable of running at is 360 rpm.

1. Select **Speed limit** from the **CONTROL SETTINGS** menu to define a lower maximum speed limit for the pump.
This speed limit will be applied to all operating modes.
2. Use the \wedge / \vee keys to adjust the value and press **SAVE** to set.

Reset run hours

1. Select **Reset run hours** from the **CONTROL SETTINGS** menu.
2. Select **RESET** to zero the run hours counter. The run hours counter can be viewed by pressing **INFO** from your home screen. The following screen will be displayed. Press **RESET** to reset the run hours or **CANCEL** to return to the **CONTROL SETTINGS** menu.



15.5 Configure inputs

1. Select **Configure inputs** from the **CONTROL SETTINGS** menu.
2. Use the \wedge / \vee keys and press **SELECT** to choose which input to configure.



3. Use the \wedge / \vee keys and press **SELECT** to choose the logic state of the chosen input.
4. Press **SELECT** to program the output or **BACK** to cancel.

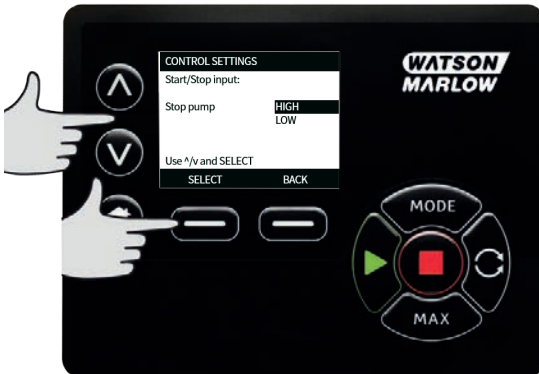

5. NOTE: On this model, Inputs 4 and 5 are configured for a pressure sensor.

Disable remote stop in Manual mode

1. Users can disable/enable the remote stop input when the pump is in **Manual** mode by using the following sequence to configure the **start/stop** settings.

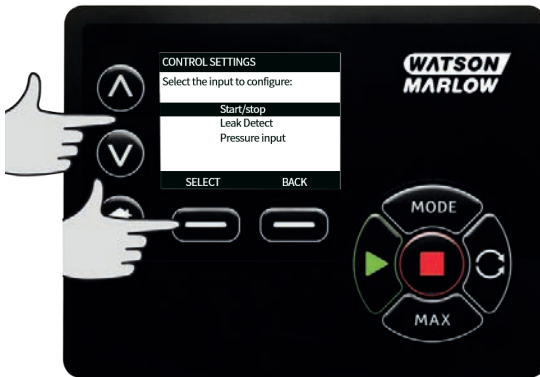

2. The default is ✖. The start/stop input is not disabled in **Manual** mode. Press **SELECT** to change the setting to ✔.



3. Press **HOME** to return and store the setting. The input is now disabled in **Manual** mode.



Enable remote stop in Manual mode

1. The setting is ✓. The start/stop input is disabled. Press **SELECT** to open the logic state menu.



2. Use the \wedge / \vee keys and press **SELECT** to choose the logic state of the chosen input for your connected control hardware.



- Press **HOME** to return and store the setting. The input is now enabled in **Manual** mode.



15.6 Help

Help

- Select Help from the main menu to access the help screens.



SOFTWARE VERSIONS	BOOTLOADER VERSIONS
Main Processor Code: 1.2	Main Processor Code: 1.2
HMI Processor Code: 1.2	HMI Processor Code: 1.2
HMI Screen Resources: 1.2	
PROLOGIS@ProcessCode: 1.2	
BOOTLOADER BACK	BACK

16 Mode menu

1. Press **MODE** to display the **CHANGE MODE** menu.
2. Use the \wedge / \vee keys to scroll through the available modes.
 - **Manual (default)**
 - **Flow Calibration**
 - **PROFINET**
 - **BACK**
3. Use **SELECT** to choose mode. Use the right hand function key to alter mode settings.



17 Manual

All settings and functions of the pump in **Manual** mode are set and controlled by means of key-presses. Immediately after the start-up display sequence detailed in: "Switching the pump on in subsequent power cycles " on page 39, the **Manual** mode home screen will be displayed unless **Auto Restart** is enabled.

If **Auto Restart** is enabled the pump will return to the last known settings when the power is re-applied. When the pump is running it displays an animated clockwise arrow. In normal operation, the direction of flow is into the bottom port of the pumphead and out of the top port.

If an exclamation mark (!) is displayed, it indicates that the pump could automatically restart at any time. In **Manual** mode, the **Auto Restart** behaviour is configurable. If a padlock icon shows, it indicates that the keypad lock is on.

17.1 Start

1. Starts the pump, and the display background changes to grey. If the pump is already running, pressing this has no effect.



17.2 Stop

1. Stops the pump. The display background changes to white. If the pump is not running pressing this has no effect.



17.3 Increasing and decreasing flow rate

1. Using the \wedge / \vee keys will increase or decrease the flow rate.



Decreasing flow rate

- A single key press will decrease flow rate by the least significant digit of the chosen flow rate unit.
- Repeat key presses as required to achieve the desired flow rate.
- Hold down the key for flow rate scrolling.

Increasing flow rate

- A single key press will increase flow rate by the least significant digit of the chosen flow rate unit.
- Repeat key presses as required to achieve the desired flow rate.
- Hold down the key for flow rate scrolling.

MAX FUNCTION (Manual mode only)

1. Using the MAX key:



- Press and hold the **MAX** key to run at maximum flow.
- Release the key to stop the pump.
- The volume pumped and time elapsed are displayed while the **MAX** key is pressed and held.

18 Flow calibration

This pump displays flow rate in ml/min.

18.1 Setting the flow calibration

1. Using the \wedge \vee keys, scroll to **Flow calibration** and press **CALIBRATE**.



2. Using the \wedge \vee keys, enter the maximum flow rate limit and press **ENTER**.



3. Press **START** to begin pumping a volume of fluid for calibration.



4. Press **STOP** to stop pumping fluid for the calibration.



5. Use the \wedge / \vee keys to enter the actual volume of fluid pumped.

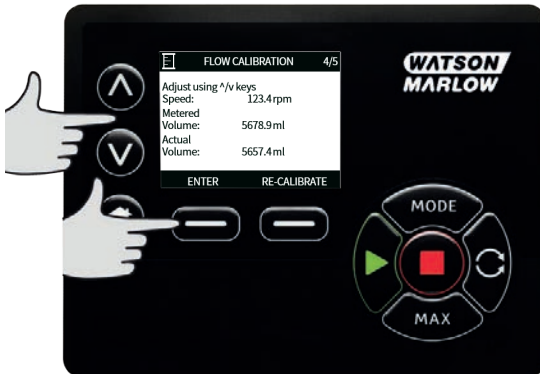

6. To accept the new calibration press **ACCEPT** or **RE-CALIBRATE** to repeat the procedure. Press **HOME** or **MODE** to abort.



7. The pump is now calibrated.

19 PROFINET® mode

19.1 Behaviour on start up

IOPS = bad

If the Input Output Provider Status (IOPS) associated with a sub module is BAD (any value other than 0x80), then the I/O data of that sub module as viewed over PROFINET® will be cleared to zeroes. The equivalent parameters viewed on the TFT screen, or over the web interface, are not cleared. Upon receiving a network message with IOPS=BAD, no parameters of the pump that were attempted to be written will be updated, and the Network Status LED will flash once in green. The pump will continue to respond normally however, to any valid future messages. By default, the motor will stop if IOPS=BAD, but this behaviour can be customised using the **failsafe** settings.

Disconnection

If a PROFINET® connection is aborted (for example, the Ethernet cable is disconnected), then the I/O data of all sub modules as viewed over PROFINET® are cleared to zeroes. The equivalent parameters viewed on the TFT screen, or over the web interface, are not cleared. New connections may be established without needing to reboot the pump. By default, the motor will stop upon losing connection, but this behaviour can be customised using the **failsafe** settings.

Mains power on

The I/O data of all sub modules as viewed over PROFINET® will be cleared to zeroes. This does not clear the parameters stored on the pump itself.

By default, the motor is stopped on power on, however this behaviour can be modified using the **Auto Restart** setting.

Table 9 - PLC Errors

PLC Error	Pump Behaviour
IOPS = bad	Stopped – can be modified using the failsafe setting
Disconnected connection	Stopped – can be modified using the failsafe setting
Mains power on	Stopped – can be modified using the Auto Restart setting

19.2 Configure PROFINET® settings

Table 10 - Configure PROFINET® settings

Setting	Value
DHCP Enable	Off
IP Address	192.168.001.012
Subnet mask	255.255.255.000
Gateway address	192.168.001.001

1. Press the **MODE** key to access the **MODE** menu.



2. Use the \wedge / \vee keys to select **PROFINET®**.



3. Press the **SELECT** key to use **PROFINET®** mode.



4. Press the **SETTINGS** key to access the **PROFINET® SETTINGS** menu.

Setting DHCP Enable

1. Press the **DISABLE** key to set **DHCP Enable** to **Off**.



Setting the IP Address, Subnet mask and Gateway address

Configure each of the IP Address, subnet mask and gateway address in turn using the following method:

1. Use the \wedge / \vee keys to select the setting to configure. Press **SET** to enter the **SET ADDRESS** menu.



- Use the \wedge / \vee keys to set the first number. Hold the \wedge / \vee key increase the scrolling speed. Press **NEXT** to move to the next number.



- After setting the last number, press **CONFIRM** to store the number and return to the **PROFINET® SETTINGS** screen.
- Press **BACK** to return to the **MODE MENU**.



19.3 PROFINET® mode

1. From the **CHANGE MODE** menu, highlight **PROFINET®** and press **SELECT** to use **PROFINET®** mode.



2. The pump display will show a network error as indicated below if the pump is not connected to a PROFINET® controller.



3. If the pump is connected to a PROFINET® controller, press **INFO** to display the network settings.

19.4 Pump parameters

All available pump parameters are grouped in to modules as listed below:

- Pump Details and set up
- Pump Status
- Pump Control
- Errors and Warnings

Table 11 - Pump details and set up

ADI	Name	Access	Type	Description
17	Pressure min warning setpoint (deciPSI)	Read	SInt32	Displays the Pressure low warning band set point in deci-psi
18	Pressure max warning setpoint (deciPSI)	Read	SInt32	Displays the Pressure high warning band set point in deci-psi
19	Pressure min alarm setpoint (deciPSI)	Read	SInt32	Displays the Pressure low alarm band set point in deci-psi
20	Pressure max alarm setpoint (deciPSI)	Read	SInt32	Displays the Pressure high alarm band set point in deci-psi
21	Flow min warning setpoint ($\mu\text{L}/\text{min}$)	Read	SInt32	Displays the Flow low warning band set point in $\mu\text{L}/\text{min}$
22	Flow max warning setpoint ($\mu\text{L}/\text{min}$)	Read	SInt32	Displays the Flow high warning band set point in $\mu\text{L}/\text{min}$
23	Flow min alarm setpoint ($\mu\text{L}/\text{min}$)	Read	SInt32	Displays the Flow low alarm band set point in $\mu\text{L}/\text{min}$
24	Flow max alarm setpoint (μL)	Read	SInt32	Displays the Flow high alarm band set point in $\mu\text{L}/\text{min}$
35	Tube wall size (mm)	Read	UInt8 (Enum)	Displays the currently selected tube wall size. See Wallsize enumeration table
36	Tube bore size (mm)	Read	UInt8 (Enum)	Displays the currently selected tube bore size. See BoreSize enumeration table
38	Pump head	Read	UInt8 (Enum)	Displays the currently selected pump head. See PumpHead enumeration table
39	Pressure sensor model	Read	UInt8 (Enum)	Displays the currently selected pressure sensor model. Please see PressureSensorModel enumeration table
40	Pressure sensor size	Read	UInt8 (Enum)	Displays the currently selected pressure sensor size. Please see PressureSensorSize enumeration table
41	Flow sensor model	Read	UInt8 (Enum)	Displays the currently selected flow sensor model. Please see FlowSensorModel enumeration table

Table 11 - Pump details and set up

ADI	Name	Access	Type	Description
42	Flow sensor size	Read	UInt8 (Enum)	Displays the currently selected flow sensor size. Please see FlowSensorSize enumeration table

Table 12 - Pump Status

ADI	Name	Access	Type	Description
13	Flow calibration (μ L/rev)	Read	UInt32	Reports the Flow calibration value.
14	Run hours	Read	UInt32	Reports the number of hours the pump has run
15	Sensor flow rate (μ L/min)	Read	SInt32	Reports a value if the flow sensor is setup
16	Sensor pressure (deciPSI)	Read	SInt32	Reports a value if the pressure sensor is setup
25	Total volume pumped (μ L)	Read	UInt32	Displays the totalised flow value
26	Pump Head revolution count	Read	UInt32	Displays the revolution count in full rotations
27	Current pump speed (deciRPM)	Read	UInt16	Displays the current pump speed set point
28	Pump speed limit (deciRPM)	Read	UInt16	Displays the current speed limit set point
103	Status bitfield	Read	byte	Bit 0 Pump running anti clock wise, if set pump is running anti clockwise Bit 1 Pump is currently running, if set pump is currently running

Table 13 - Pump Control

ADI	Name	Access	Type	Description
2	Set pump speed (deciRPM)	Write	UInt16	Speed is set in Deci RPM. Max speed depends on head type. See Pump Head enumeration table
3	Set pump speed limit (deciRPM)	Write	UInt16	Speed is set in Deci RPM. Max speed depends on head type. See Pump Head enumeration table
4	Set failsafe speed (deciRPM)	Write	UInt16	If the failsafe is enabled the pump will run continuously at the selected speed in the event of a communications loss.
101	Control bitfield	Write	UInt16	<p>Bit 0 Set fail safe enable, Enabled the failsafe speed. If disabled the pump will stop in the event of a communications loss. If enabled the pump will run at the speed set in the "SetFailsafeSpeed" parameter</p> <p>Bit 1 Set pump direction to anti-clockwise, If set the pump will run anti-clockwise. Pump defaults to clockwise rotation</p> <p>Bit 2 Start pump, Set to 1 (true) to allow the pump to run. 0 will stop the pump. Note that pump enable needs to be set</p> <p>Bit 3 Enable pump, Need to set to 1 to allow pump to run. Setting to 0 will stop the pump and not allow the pump to run.</p> <p>Bit 4 Reset pump run hours to zero, Resets the run hours accumulator</p> <p>Bit 5 Pause flow totaliser, Set to 1 to pause the internal Total volume pumped parameter. Setting to 0 will un-pause the parameter</p> <p>Bit 6 Reset flow totaliser to zero, Set to 1 to reset the Total volume pumped to 0. Set to 0 to allow the Total volume pumped to accumulate</p> <p>Bit 7 Reset revolution count to zero, Set to 1 to reset the Pump head revolution count to 0. Set to 0 to allow the Pump head revolution count to increment.</p>

Table 14 - Errors and warnings

ADI	Name	Access	Type	Description	
102	Error bit field	Read	Uint32	Bit 0	Lead detected, Leak detect signal high requires clearing and acknowledging before pump can resume.
				Bit 1	Motor Stall error active If Set the pump has a Motor Stall Error. Please follow onscreen instructions
				Bit 2	Motor Speed error, If set pump has a speed error. Please follow onscreen instructions
				Bit 3	Over Current error active, If set the pump has an over current error. Please follow onscreen instructions
				Bit 4	Over voltage error active, If set the set the pump has an over voltage error. Please follow onscreen instructions
				Bit 5	Guard open, If set then the guard has been opened. Please follow onscreen instructions to clear.
				Bit 6	Flow sensor error active, if set flow sensor error is active
				Bit 7	Pressure sensor error active, if set flow sensor error is active

Table 14 - Errors and warnings

ADI	Name	Access	Type	Description
				Bit 0 Flow sensor max alarm active, If set the flow sensor high alarm is active
				Bit 1 Flow sensor min alarm active, If set the flow sensor low alarm is active
				Bit 2 Flow sensor max warning active, If set then the flow sensor high warning is active
				Bit 3 Flow sensor min warning active, If set the flow sensor low warning is active
				Bit 4 Pressure sensor max alarm active, if set the pressure sensor high alarm is active
				Bit 5 Pressure sensor min alarm active, If set the pressure low alarm is active
				Bit 6 Pressure sensor max warning active, If set the pressure high warning is active
				Bit 7 Pressure sensor min warning active, If set the pressure sensor low warning is active
				Bit 0 Pressure switch active, if set then pressure switch input is active
64	Acknowledge	Read/Write	UInt8	Bit 0 Acknowledge error, If set to 1 will acknowledge pump errors

19.5 GSDML compatibility guide

Table 15 - GSDML compatibility guide

GSDML file (Found on website)	GSDML release Date	Pump Models	Compatible with pump software versions	Version comments
GSDML-V2.4-Watson Marlow-530_630_730 Profinet Pump-20211116.xml	January 2021	530Pn, 630Pn, 730Pn	0.41.03	Initial GSDML release

Link to GSDML file location:

1. Navigate to: <https://www.wmftg.com/en/literature/other-resources/software-and-devices/>

Notes:

1. If your pump software is compatible with multiple GSDML files versions it is recommended to use the latest version available.
2. In order to find your pump software version, select **Help**, then **Software** on your pump
3. The correct GSDML file version must be used in combination with the pump software versions listed for good communication between the pump and control system.
4. Networks using pumps with different software and GSDML versions are acceptable as long as each pump is using the correct GSDML version

20 Sensors

Sensors can be connected to the pump to display the value, warnings and errors on pressure and or flow as selected.

Attached sensors allow the user to configure warning and alarm set points on the pump.

Each pump can support a maximum of one flow sensor and one pressure sensor at the same time.

20.1 Sensor wiring

Make sure the sensor is correctly wired to the pump before proceeding with set up. ("Control wiring" on page 23 or "Input/output connectors" on page 30).

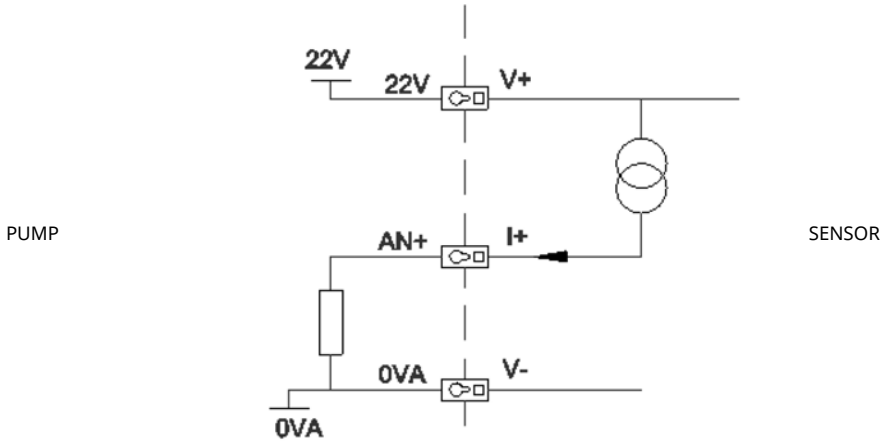

Figure 20 - Sensor wiring

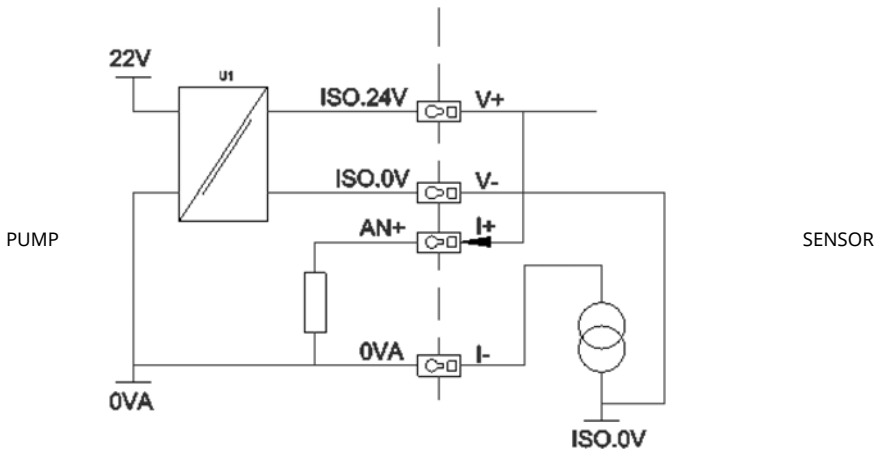

Figure 21 - Sensor wiring

20.2 Setting up the sensors

1. From the **CONTROL SETTINGS** menu, using the \wedge / \vee keys, scroll to **Sensors settings** option and press **SELECT**.



2. Using the \wedge / \vee keys, scroll to **Configure sensors** option and press **SELECT**.



3. Using the \wedge / \vee keys, scroll to **Flow** or **Pressure** option and press **SELECT**. This selects the type of sensor to configure.



4. A list of supported flow sensor families are displayed. The example in the image above shows supported flow sensors. Using the \wedge / \vee keys, scroll to the desired flow sensor and press **SELECT**.

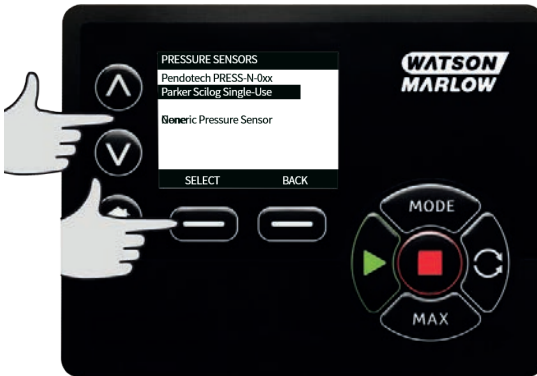

5. The input that the sensor is attached to needs to be assigned.

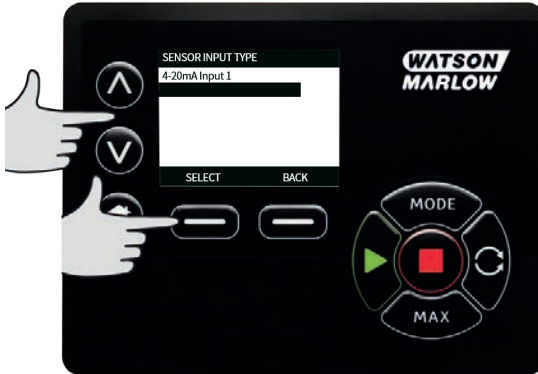

6. Using the \wedge / \vee keys, scroll to the desired flow sensor and press **SELECT**.



7. See "PROFINET® control wiring" on page 21 section for connection specifications.

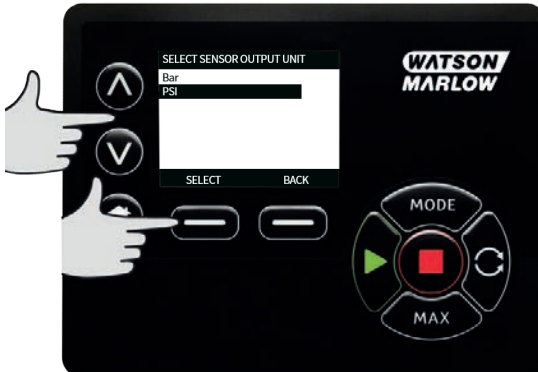

8. Using the \wedge / \vee keys, scroll to the desired sensor size and press **SELECT**.

- Using the \wedge / \vee keys, scroll to the desired output unit and press **SELECT**.
- This choice will alter the units displayed on the home screen.

Set Alarm and Warning level

- Using the \wedge / \vee keys, scroll to the alarm level to set up and press **SELECT**.



- Using the \wedge / \vee keys, enter a value and press **SELECT** to store. Each one of these defaults to none, once the user sets a value in the edit screens the alarm/warning will become active.



3. When a warning level is triggered the top or bottom bars will show orange



4. When an alarm band is triggered the pump will display the “sensor alarm detected” screen and the pump will stop.



20.3 Start up delay

Sets the delay from the motor starting to the alarms/warnings activating. Start-up delay activates on a motor start (irrelevant of mode, includes **MAX**).

1. From the control settings menu, using the \wedge / \vee keys, scroll to **Sensor settings** option and press **SELECT**



2. From the control settings menu, using the \wedge / \vee keys, scroll to **Set sensor delay** option and press **SELECT**



3. Using the \wedge / \vee keys, set a value and press **SELECT** to store.



20.4 Generic sensors

Generic Sensors allow any sensor with a 4-20 mA output and a linear response to be used on the system. The sensor max flow/pressure ratings are shown in a table at the end of this section.

1. From the control settings menu, using the \wedge/\vee keys, scroll to **Sensor settings** option and press **SELECT**



2. Using the \wedge/\vee keys, scroll to **Configure sensors** option and press **SELECT**



3. Using the \wedge/\vee keys, scroll to **Flow** or **Pressure** option and press **SELECT**. This selects the type of sensor to configure.



4. Using the \wedge/\vee keys, scroll to **Generic flow sensor** or **Generic pressure sensor** option and press **SELECT**.

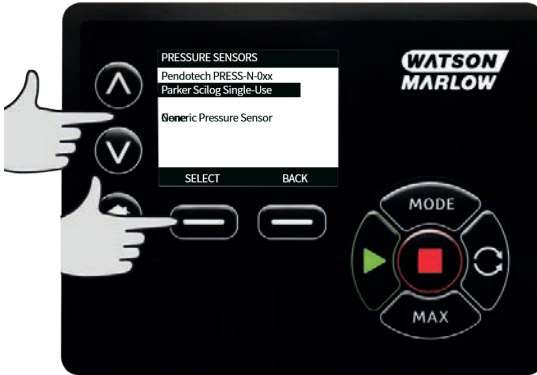

- Using the \wedge/\vee keys, scroll to **4-20mA input 1** or **4-20mA input 2** option and press **SELECT**. This depends on which connection the user has connected the sensor to. See "PROFINET® control wiring" on page 21 section for connection specifications. Only generic sensors which provide a 4-20 mA output are supported.



- Using the \wedge/\vee keys, select the sensor unit output type and press **SELECT**. Options in table below depending on sensor type selection:



Table 16 - Sensor units

Flow	Pressure
ul/min	Bar
ml/min	Psi
ml/hr	
l/min	
l/min	

7. After selecting the sensor unit type the user will progress onto the **GENERIC SENSOR VALUES** screen.



8. Using the \wedge/\vee keys, scroll to **Set 4mA value**



9. Using the \wedge/\vee keys, change the value reported when the sensor input is at 4 mA. Once satisfied with the value press **SELECT**.



10. Using the \wedge/\vee keys, scroll to **Set 20mA value**



11. Using the \wedge/\vee keys, change the value reported when the sensor input is at 20 mA. Once satisfied with the value press **SELECT**.



12. Depending on the sensor and units selected the maximum values that can be set at below

Table 17 - Sensor pressure limits

Pressure Unit	Minimum	Maximum
PSI	-10.0	75
Bar	-0.689	5.171

Table 18 - Sensor flow limits

Flow Unit	Minimum	Maximum
ul/min	0	60000000
ml/min	0	60000
ml/hr	0	900000
l/min	0	60
l/hr	0	900

Alarm / warning levels

The Warning / error levels screen will then be shown, refer to "Set Alarm and Warning level" on page 91. The error and warning values will default to the value set at 4 mA and 20 mA. The user should set up warnings and errors to suit their process.

Example

If using a 4-20 mA sensor with a range of 0-10 psi:

- Set the 4 mA to 0 psi
- Set the 20 mA to 10 psi
- The Alarm Max was set at 8 psi
- The Warning Max was set at 7 psi
- The Warning Min was set at 3 psi
- The Alarm Min was set at 2 psi

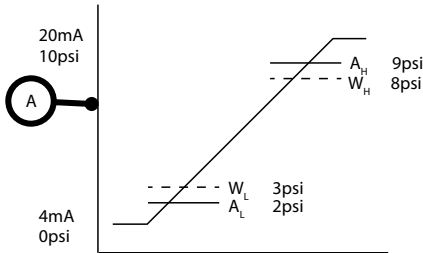

Figure 22 - Set Alarm / warning levels

A

Current (A) / Pressure (psi)

An alarm event is indicated by the solid lines (A_L , A_H) on the graph. During an alarm event the pump will show the alarm red screen and stop. This alarm is triggered by the sensor signal being equal to or greater than that set by the Alarm Max/Min or Ethernet Hi-Hi/Lo-Lo Parameters. The user has to acknowledge this screen on the pump.

A warning event is indicated by the dashed lines (W_L , W_H) on the graph. During a warning event the pump will show orange sections on the screen and a warning bit will flag on the Ethernet communications. This event is triggered by the sensor signal being equal to or greater than the value set by the Warning Max/Min or Ethernet Hi-Lo/Lo-Hi Parameters.

Note: It is normal to expect fluctuations in both pressure and flow systems using peristaltic pumps. This means that warning and alarm limits need to take short term spikes and changes into account when setting these limits.

Note: The pump has no control over the accuracy of the signals coming from the sensors and will simply respond to the signal levels received. Sensor accuracy is the responsibility of the sensor supplier and will be dependent on a range of system variables, for example fluid type, tube material and temperature.

Procedure

1. From the **GENERIC SENSOR VALUES** screen.



2. Using the \wedge/\vee keys, scroll to **Alarm / warning levels**

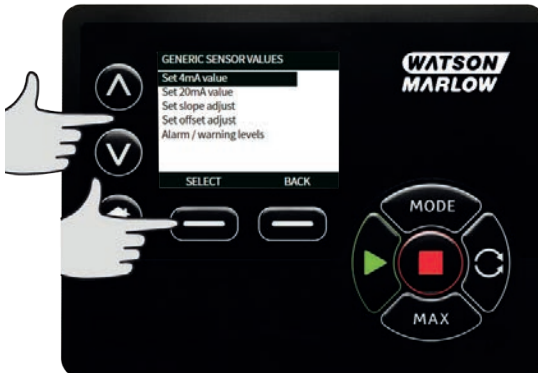

3. Using the \wedge/\vee keys, select the value to change and press **SELECT**.



4. Using the \uparrow/\downarrow keys, scroll to the desired value and press **SELECT**
5. Press **BACK** to store the changes and return to the **GENERIC SENSOR VALUES** screen

Scaling factor for generic sensors

Set slope adjust

The slope parameter will scale the slope of the channel as defined by the 4mA and the 20mA points. The parameter can take a value from 0.8 to 1.2 where 1 will result in no change to the slope.

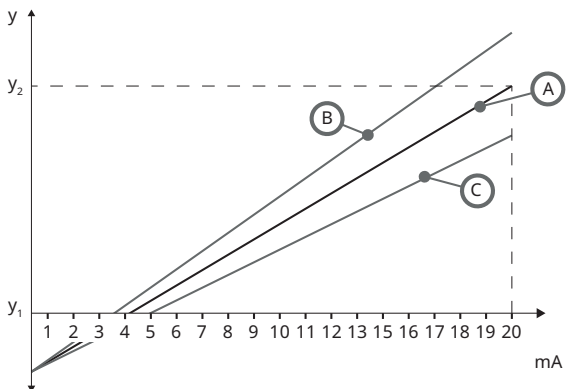

Figure 23 - Set slope adjust

A Sensor configuration determined by the 4mA value and 20mA value

B Set slope adjust is greater than 1

C Set slope adjust is less than 1

y_1 4mA value ("Generic sensors" on page 94)

y_2 20mA value ("Generic sensors" on page 94)

Procedure

1. From the **GENERIC SENSOR VALUES** screen.



2. Using the \uparrow/\downarrow keys, scroll to **Set slope adjust**

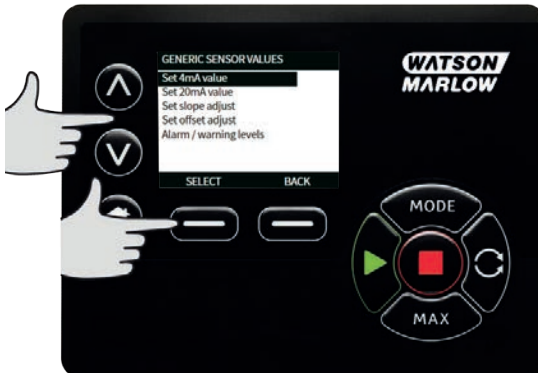

3. Using the \uparrow/\downarrow keys, scroll to the desired value and press **SELECT**



Set offset adjust

The offset parameter will apply an offset across the mA range of the channel and not affect the slope.

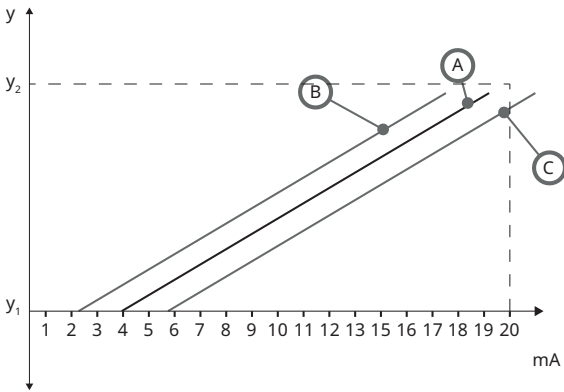

Figure 24 - Set offset adjust

A Sensor configuration determined by the 4mA value and 20mA value

B Set offset adjust is greater than 1

C Set offset adjust is less than 1

y_1 4mA value

y_2 20mA value

Procedure

1. From the **GENERIC SENSOR VALUES** screen.



- Using the \wedge/\vee keys, scroll to **Set offset adjust**



- Using the \wedge/\vee keys, scroll to the desired value and press **SELECT**



20.5 Flow sensor reading

- The flow sensor value can be read via the Flow sensor reading screen



21 Troubleshooting

If the pump display remains blank when the pump is switched on, make the following checks:

- Check that the mains power is available to the pump.
- Check the fuse in the wall plug if one is present.
- Check the position of the voltage selector switch.
- Check the mains power switch at the rear of the pump.
- Check the fuse in the fuse holder in the centre of the switch plate at the rear of the pump.

If the pump runs but there is little or no flow, make the following checks:

- Check that fluid is supplied to the pump.
- Check for any kinks or blockages in the lines.
- Check that any valves in the line are open.
- Check that the tube and rotor are in the pumphead.
- Check that the tube is not split or burst.
- Check that the correct wall-thickness tube is being used.
- Check the direction of rotation.
- Check that the rotor is not slipping on the drive shaft.

If the pump turns on, but will not run:

- Check the remote stop function and configuration.
- Check the mode you are in, are you in **Analog** mode.
- Try to operate and run the pump in **Manual** mode.

21.1 Error codes

If an internal error occurs, an error screen with a red background is displayed. Note: Signal out of range, over signal and leak detected error screens report the nature of an external condition. They do not flash.

Table 19 - Error codes

Error code	Error condition	Suggested action
Er 0	FRAM write error	Attempt to reset by switching power OFF/ON. Or seek support.
Er 1	FRAM corruption	Attempt to reset by switching power OFF/ON. Or seek support.
Er 2	FLASH write error during drive update	Attempt to reset by switching power OFF/ON. Or seek support.
Er 3	FLASH corruption	Attempt to reset by switching power OFF/ON. Or seek support.
Er 4	FRAM shadow error	Attempt to reset by switching power OFF/ON. Or seek support.

Table 19 - Error codes

Error code	Error condition	Suggested action
Er 9	Motor stalled	Stop pump immediately. Check pumphead and tube. Power OFF/ON may reset. Or seek support.
Er10	Tacho fault	Stop pump immediately. Power OFF/ON may reset. Or seek support.
Er14	Speed error	Stop pump immediately. Power OFF/ON may reset. Or seek support.
Er15	Over current	Stop pump immediately. Power OFF/ON may reset. Or seek support.
Er16	Over voltage	Stop pump immediately. Check supply. Power OFF/ON may reset.
Er17	Under voltage	Stop pump immediately. Check supply. Power OFF/ON may reset.
Er20	Signal out of range	Check analog control signal range. Trim signal as required. Or seek support.
Er21	Over signal	Reduce the analog control signal.
Err50	Communication error (internal pump communications error and not a network error)	Attempt to reset by switching power OFF/ON. Or seek support.

21.2 Technical support

Watson-Marlow Fluid Technology Group
Falmouth, Cornwall
TR11 4RU
UK

Contact your local Watson-Marlow representative for support.
www.wmftg.com/contact

22 Drive maintenance

There are no user serviceable parts inside the pump. Please contact your local Watson-Marlow representative to arrange repair.

23 Drive spares

Table 20 - Drive spares

Description	Part No.
Replaceable main fuse, type T5A, H 250 V 20 mm (Pack of 5)	MRA3083A
Foot (Pack of 5)	MNA2101A
Module Seal	MN2516B
Module switch cover	MN2505M
Gland (Std)	GR0056
Glands (EMC)	GR0075
Sealing washer for blanking plug or gland	GR0058
Snap-Fit vent	MN2513B
M12 cover	MN2943B
M12 collars insulated	MN2934T
M12 collars non insulated	MN2935T
RJ45(skt) TO M12 D CODE (skt) ADAPTER IP68	059.9124.000
Leak Detector Kit for 730 En	079.9151.000
Leak Detector Kit for 730 EnN	079.9161.000
RJ45 to RJ45 Patch Cable	059.9125.000

24 Pumphead replacement



Always isolate the pump from the mains power supply before opening any guard or track, or performing any positioning, removal or maintenance operation.



Primary safety is provided by the tool-lockable pumphead track. Secondary (backup) protection is provided in the form of a guard switch which stops the pump if the pumphead track is opened. The guard switch on cased pumps should never be used as primary protection. Always disconnect the mains power supply to the pump before opening the pumphead guard.

24.1 720R and 720RE pumphead replacement



1.



2.



3.



4.



5.



6.

720RX and 720REX

Removal



1.



2.



3.

Refitting



1.



2.



3.

25 Tube replacement



Always isolate the pump from the mains power supply before opening any guard or track, or performing any positioning, removal or maintenance operation.

25.1 Continuous tubing

720R

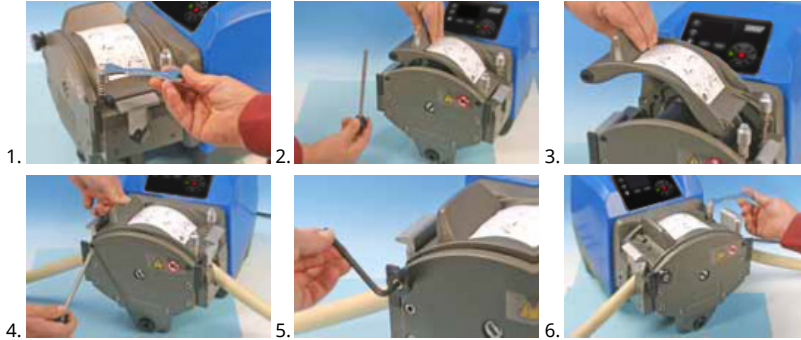

25.2 Tube elements

720RE

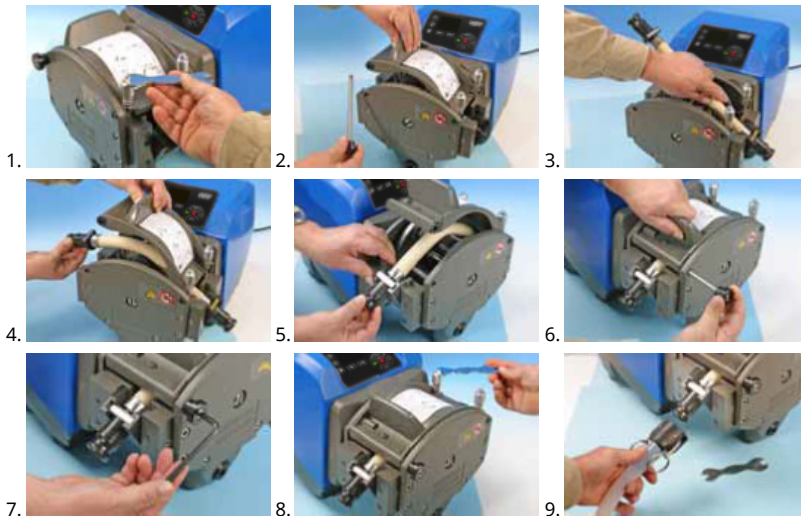
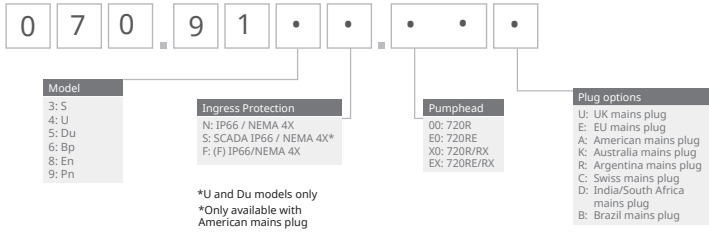

Table 21 - General guide to cleaning with solvents

Chemical	Cleaning precautions
Aliphatic hydrocarbons	Remove guard. Minimize rotor cap and clutch boot exposure to less than one minute (risk of attack).
Aromatic hydrocarbons	Remove guard. Minimize rotor cap and clutch boot exposure to less than one minute (risk of attack).
Ketone solvents	Remove guard. Minimize rotor cap and clutch boot exposure to less than one minute (risk of attack).
Halogenated/chlorinated solvents	Not recommended: possible risk to polycarbonate tube clamp adjusters and polypropylene tube clamp locators.
Alcohols, general	No precaution necessary.
Glycols	Minimize rotor cap and clutch boot exposure to less than one minute (risk of attack).
Estersolvents	Remove guard. Minimize rotor cap and tube clamp location cap exposure to less than one minute (risk of attack).
Ether solvents	Not recommended: possible risk to polycarbonate tube clamp adjusters and polypropylene tube clamp locators.

26 Ordering information

26.1 Pump part numbers



*(F) module for KROHNE flow sensor

26.2 Tubing and element part numbers

Table 22 - Continuous tubing for 720R pumpheads



mm	inch	#	Marprene	Bioprene	Pumpsil silicone
9.6	3/8	193	902.0096.048	933.0096.048	913.A096.048
12.7	1/2	88	902.0127.048	933.0127.048	913.A127.048
15.9	5/8	189	902.0159.048	933.0159.048	913.A159.048
19.0	3/4	191	902.0190.048	933.0190.048	913.A190.048
25.4	1	92	902.0254.048	933.0254.048	913.A254.048
mm	inch	#	Neoprene	STA-PURE Series PCS	
9.6	3/8	193		961.0096.048	
12.7	1/2	88	920.0127.048	961.0127.048	
15.9	5/8	189	920.0159.048	961.0159.048	
19.0	3/4	191	920.0190.048	961.0190.048	
25.4	1	92	920.0254.048	961.0254.048	

Table 23 - Sanitary elements with PVDF Tri-clamp style connectors

mm	inch	#	STA-PURE Series PCS	Bioprene TL	Pumpsil silicone
12.7	1/2	88	961.0127.PFT	933.0127.PFT	913.A127.PFT
15.9	5/8	189	961.0159.PFT	933.0159.PFT	913.A159.PFT
19.0	3/4	191	961.0190.PFT	933.0190.PFT	913.A190.PFT
25.4	1	92	961.0254.PFT	933.0254.PFT	913.A254.PFT

Table 24 - Industrial elements with PP Cam-and-Groove connectors

mm	inch	#	Marprene TL	Neoprene	Pumpsil silicone
12.7	1/2	88	902.0127.PPC	920.0127.PPC	913.A127.PPC
15.9	5/8	189	902.0159.PPC	920.0159.PPC	913.A159.PPC
19.0	3/4	191	902.0190.PPC	920.0190.PPC	913.A190.PPC
25.4	1	92	902.0254.PPC	920.0254.PPC	913.A254.PPC

26.3 Pumphead spares

Continuous tubing models 720R and 720RX

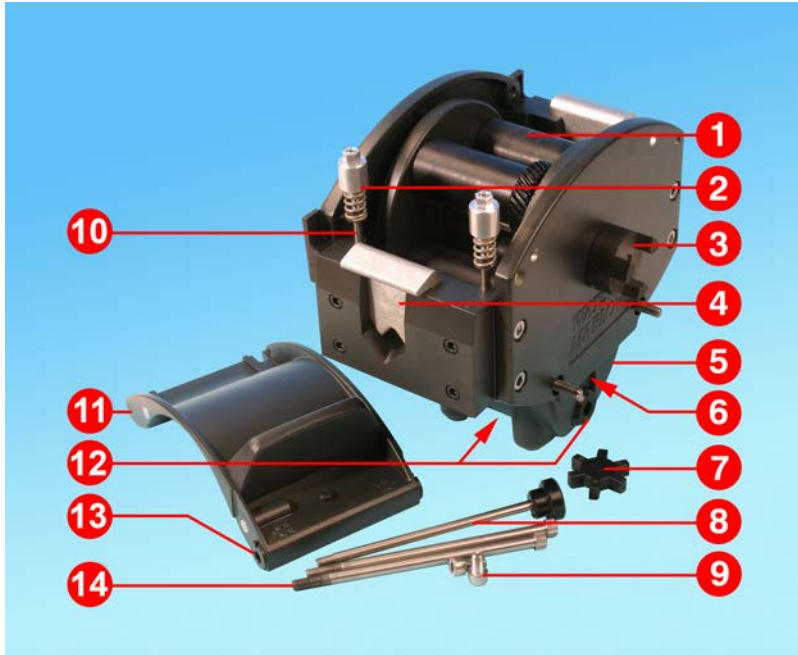

Figure 25 - Continuous tubing models 720R and 720RX

Table 25 - Continuous tubing models 720R and 720RX

Number	Spare	Description
1	MRA3062A	Rotor assembly (720R)
1	MRA0036A	Rotor assembly (720RX)
2	MRA0104A	Knob assembly (4.8 mm wall tubing)
3	CN0090	Coupling half
4	MR0880C	Tube clamp
5	MRA3061A	Foot assembly
6	CN0229	M12 blanking plug
7	CN0088	Coupling spider
8	MRA0027A	Pivot pin assembly
8	MRA0034A	Pivot pin assembly (720RX)

Table 25 - Continuous tubing models 720R and 720RX

Number	Spare	Description
9	FN0611	M8 x 16 mm screw
10	MR0662T	Stud (Set to 61 mm)
11	MRA3063A	Track assembly
12	CN0228	M25 blanking plug
13	MR0882M	Eccentric bush
14	MR3041T	M8 x 307 mm bolt (720RX)
14	MR3040T	M8 x 157 mm bolt (720R)

LoadSure element models 720RE and 720REX



Figure 26 - LoadSure element models 720RE and 720REX

Table 26 - LoadSure element models 720RE and 720REX

Number	Spare	Description
1	MRA3062A	Rotor assembly (720RE)
1	MRA0036A	Rotor assembly (720REX)
2	MRA0319A	Knob assembly (4.8 mm wall tubing)
3	CN0090	Coupling half
4	MR1118T	Sliding clamp
5	MRA3061A	Foot assembly
6	CN0229	M12 blanking plug
7	CN0088	Coupling spider
8	MRA0027A	Pivot pin assembly
8	MRA0034A	Pivot pin assembly (720REX)

Table 26 - LoadSure element models 720RE and 720REX

Number	Spare	Description
9	FN0611	M8 x 16 mm screw
10	MR0662T	Stud (Set to 61 mm)
11	MRA3064A	Track assembly
12	CN0228	M25 blanking plug
13	MR0882M	Eccentric bush
14	MR3041T	M8 x 307 mm bolt (720REX)
14	MR3040T	M8 x 157 mm bolt (720RE)

27 Performance data

27.1 720R, 720RE, 720R/RX and 720RE/REX performance data

Pumping conditions

All performance figures in this operating instruction have been recorded against peak pipeline pressures.

This pump is rated to 2 bar (30psi) peak pressure when fitted with a 720R, 720RE, 720R/RX or 720RE/REX pumphead using high-pressure tubing. However, it will generate in excess of 4 bar (58psi) peak pressure if the pipeline is restricted. Where it is important that 2 bar (30psi) is not exceeded, pressure relief valves should be installed in the pipeline.

At discharge pressures exceeding 1 bar (15psi) the flow performance may be de-rated. This is particularly the case with twin pumpheads. Please refer to the performance tables below.

Note: Flow rates quoted have been rounded for simplicity, but are accurate to within 5% - well within the normal tubing tolerance variation of flow rate. They should therefore be taken as a guide. Real flow rates in any application must be determined empirically.

720R and 720RE flow rates

Table 27 - 730 cased pumps' performance limits

Single pumphead (720R, 720RE)	0.25 bar (3.6psi)		0.5 bar (8psi)		1 bar (15psi)		1.5 bar (22psi)		2 bar (30psi)	
	Max speed (rpm)*	Max flow L/hr (USGPH)	Max speed (rpm)*	Max flow	Max speed (rpm)*	Max flow	Max speed (rpm)*	Max flow	Max speed (rpm)*	Max flow
9.6 mm (0.4")	360	420 (111)	360	420 (111)	360	420 (111)	360	420 (111)	360	420 (111)
12.7 mm (0.5")	360	780 (206)	360	780 (206)	360	780 (206)	360	780 (206)	360	780 (206)
15.9 mm (0.6")	360	1100 (291)	360	1100 (291)	360	1100 (291)	360	1100 (291)	300	900 (238)
19.0 mm (0.7")	360	1500 (396)	360	1500 (396)	360	1500 (396)	300	1300 (343)	250	1000 (264)
25.4 mm (1.0")	360	2000 (528)	360	2000 (528)	360	2000 (528)	200	1100 (291)		

*The maximum speed is reduced at increased discharge pressures to ensure safe running of the pump

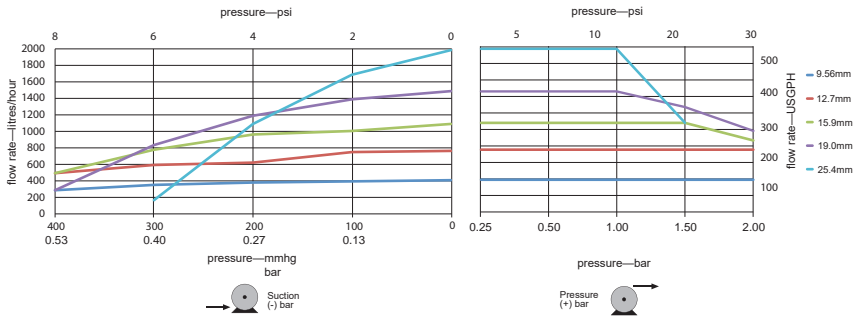

Figure 27 - 730 cased pumps' performance limits

720R/RX and 720RE/REX flow rates

Table 28 - 730 cased pumps' performance limits

Twin pumphead (720R/RX, 720RE/REX)	0.25 bar (3.6psi)		0.5 bar (8psi)		1 bar (15psi)		1.5 bar (22psi)		2 bar (30psi)	
	Max speed (rpm)*	Max flow L/hr (USGPH)	Max speed (rpm)*	Max flow	Max speed (rpm)*	Max flow	Max speed (rpm)*	Max flow	Max speed (rpm)*	Max flow
9.6 mm (0.4")	300	700 (185)	300	700 (185)	300	700 (185)	250	590 (156)	200	470 (124)
12.7 mm (0.5")	300	1300 (343)	300	1300 (343)	250	1100 (291)	200	870 (230)	175	760 (261)
15.9 mm (0.6")	300	1800 (476)	200	1200 (317)	175	1100 (291)				
19.0 mm (0.7")	300	2500 (660)	200	1700 (449)	160	1390 (366)				
25.4 mm (1.0")	300	3300 (872)	200	2200 (581)						

*The maximum speed is reduced at increased discharge pressures to ensure safe running of the pump

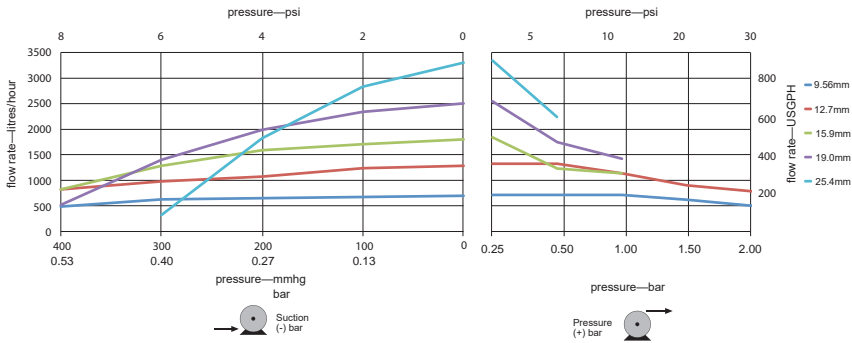

Figure 28 - 730 cased pumps' performance limits

28 Trademarks

Watson- Marlow, LoadSure, Qdos, ReNu, LaserTraceability, Pumpsil, PureWeld XL, Bioprene, Marprene, Maxthane are registered trademarks of Watson-Marlow Limited. Tri-Clamp is a registered trademark of Alfa Laval Corporate AB.

STA-PURE Series PCS and STA-PURE Series PFL are trademarks of W.L.Gore and Associates.

PROFINET® is a registered trademark of PROFIBUS and PROFINET International (PI)

Siemens is a registered trademark of Siemens AG.

SciLog® and SciPres® are registered trademarks of Parker Hannifin Corporation.

BioProTT™ is a trademark of em-tec GmbH.

PendoTECH® and PressureMAT® are registered trademarks of PendoTECH

FLEXMAG™ is a trademark of KROHNE Messtechnik GmbH

SONOFLOW® is a trademark and brand of SONOTEC Ultraschallsensorik Halle GmbH.

29 Disclaimers

The information contained in this document is believed to be correct but Watson-Marlow Fluid Technology Group accepts no liability for any errors it contains and reserves the right to alter specifications without notice.

WARNING: This product is not designed for use in and should not be used for, patient-connected applications.

30 Publication history

File	Date of issue	Notes
m-730pn-09 730Pn/PnN pump	01.22	First release

31 List of tables and figures

31.1 Tables

Table 1 - Specification ratings	12
Table 2 - Weights	13
Table 3 - Conductor colour coding	19
Table 4 - Wiring the D-Connector	24
Table 5 - Input/output Connectors	30
Table 6 - External interface parameters	32
Table 7 - Allowance for one additional connection pair	34
Table 8 - First-time start-up defaults	37
Table 9 - PLC Errors	76
Table 10 - Configure PROFINET® settings	76
Table 11 - Pump details and set up	81
Table 12 - Pump Status	82
Table 13 - Pump Control	83
Table 14 - Errors and warnings	84
Table 15 - GSDML compatibility guide	85
Table 16 - Sensor units	96
Table 17 - Sensor pressure limits	98
Table 18 - Sensor flow limits	99
Table 19 - Error codes	106
Table 20 - Drive spares	109
Table 21 - General guide to cleaning with solvents	112
Table 22 - Continuous tubing for 720R pumpheads	114
Table 23 - Sanitary elements with PVDF Tri-clamp style connectors	115
Table 24 - Industrial elements with PP Cam-and-Groove connectors	115
Table 25 - Continuous tubing models 720R and 720RX	116
Table 26 - LoadSure element models 720RE and 720REX	118
Table 27 - 730 cased pumps' performance limits	120
Table 28 - 730 cased pumps' performance limits	122

31.2 Figures

Figure 1 - 730 pump range	13
Figure 2 - Pump stacking	14
Figure 3 - Rotor direction	14
Figure 4 - Keypad layout and key IDs	16
Figure 5 - Starting and stopping	17
Figure 6 - Using up and down keys	17
Figure 7 - Maximum speed	17
Figure 8 - Change rotation direction	17
Figure 9 - Voltage selector	18
Figure 10 - Earth screening of control cables onPROFINET® NEMA module	19
Figure 11 - RJ45 connections	23
Figure 12 - Wiring the 9 way D sensor connector	23
Figure 13 - N Module and F Module	27
Figure 14 - Ethernet connection	28
Figure 15 - Adapter PCB	28
Figure 16 - Power supply options	29
Figure 17 - Star network	33
Figure 18 - Ring network	33
Figure 19 - Line topology	34
Figure 20 - Sensor wiring	87
Figure 21 - Sensor wiring	87
Figure 22 - Set Alarm / warning levels	100
Figure 23 - Set slope adjust	102
Figure 24 - Set offset adjust	104
Figure 25 - Continuous tubing models 720R and 720RX	116
Figure 26 - LoadSure element models 720RE and 720REX	118
Figure 27 - 730 cased pumps' performance limits	121
Figure 28 - 730 cased pumps' performance limits	122